

The SLV logo is located in the top right corner. It features a stylized yellow plus sign to the left of the letters 'SLV' in a white, bold, sans-serif font.

SLV

The background of the advertisement shows a dark ceiling with a track lighting system. A black track rail runs diagonally across the frame. Two cylindrical spotlights are mounted on the track; the one in the foreground is illuminated, casting a warm glow. In the upper left, a recessed circular downlight is also illuminated. The overall atmosphere is modern and sophisticated.

SLV NUMINOS®

Ein Down- und Spotlightsystem.
Tausend Möglichkeiten.





SLV NUMINOS®
DOWN- UND
SPOTLIGHTS

Das SLV NUMINOS® Leuchtensystem bietet konstante Lichteigenschaften und modernes Design über alle Anwendungen hinweg. Lassen Sie sich inspirieren.





FÜR JEDEN FALL
DIE PASSENDE
LICHTLÖSUNG.



SLV NUMINOS®

Ein Leuchtensystem – Tausend Möglichkeiten.

Das frei konfigurierbare Leuchtensystem,
das jedes Ambiente ins beste Licht rückt.

Kein Projekt ist wie das andere. Aber viele Projekte verlangen ein einheitliches Licht- und Designkonzept. SLV NUMINOS® ist ein perfekt aufeinander abgestimmtes Leuchtensystem, das Funktion, Design und Technik in Einklang bringt. Für Planer und Macher. Für jede Anforderung. Für maximale Vielfalt bei minimalem Aufwand.

NUMINOS®

HOCHLEISTUNGS LED MODUL MIT
BRILLANTER FARBWIEDERGABE



BREITE AUSWAHL AN DOWNLIGHTS
UND SPOTS FÜR EIN HARMONISCHES
DESIGNKONZEPT.



SLV NUMINOS®

MEHR FREIHEIT.

Mit System.

Was Sie auch vorhaben – das SLV NUMINOS® Leuchtensystem schafft Raum für Ideen.



Das SLV NUMINOS® Leuchtensystem bietet konstante Lichteigenschaften und modernes Design über alle Anwendungen hinweg:

- für Büroräume
- Shops & Boutiquen
- Hotellerie & Gastronomie
- Zuhause
- und vieles mehr

Vom Hotel übers Büro bis hin zu gewerblichen oder privaten Räumen. Von der Anwendung über die Technik bis zum Design im Detail: Gut, dass sich die modularen Down- und Spotlights genauso konfigurieren lassen, wie es die Planung oder Raumbedingungen erfordern. Und je facettenreicher Ihr Projekt ist, desto mehr profitieren Sie vom SLV NUMINOS® Leuchtensystem.

Licht inszenieren,
ohne zu dominieren.



SLV NUMINOS®
GIMBLE M, DL

Art.-Nr.
1005945

SLV NUMINOS®
Move S, DL

Art.-Nr.
1005340



Highlights,
die nach unten
strahlen.



SLV NUMINOS®
XL, CL
Art.-Nr.
1005767

Frei für alle
Dimensionen.



SLV NUMINOS®
Zoom M, 3Ph.
Art.-Nr.
1006116

Perfekt zum
Pendeln, in der
Höhe variabel.



SLV NUMINOS®
XL, PD
Art.-Nr.
1005783

EINZIGARTIGE VIELFALT, GEMEINSAME HIGHLIGHTS.

Wählen Sie zwischen:

- Downlight oder Spotlight
- Größen und Durchmessern
- Gehäusefarben (Schwarz/Weiß)
- Reflektorvarianten
- Schwenkbaren und starren Versionen
- Leistungsklassen

Die verschiedenen Varianten verfügen über:

- Hochleistungs LED Modul mit den Lichtfarben 2700K/3000K/4000K
- Farbqualität CRI>90
- Blendungsbewertung UGR mind. <22

EIN LEUCHTENSYSTEM.

Durchdacht bis ins Detail.



DOWNLIGHTS

- In sieben Varianten (68-75mm bis 176-186mm) mit Hochleistungs-LED-Modul in drei Lichtfarben (2700K, 3000K, 4000K) und Blendungsbewertungen (UGR 16, 19, 22) erhältlich.
- Wählbare Reflektoren mit Halbstreuwinkeln von 20°, 40° oder 55°.
- Verschiedene Effektfilter (gefrostet/prismatisch/elliptisch/Wabe) als Zubehör verfügbar.
- Dekoring als sichtbarer Abschluss in Weiß, Schwarz oder Chrom wählbar.

SLV NUMINOS® Downlights sind als starre oder schwenkbare Variante (4x fix und 3x dreh- und schwenkbar) erhältlich.



XS S M L XL

Zubehör mit System:

Ihren optionalen Treiber (On/Off, Phasendimmung, DALI) und passende Diffusoren können Sie über die Farbkodierung ganz einfach hinzufügen.

Treiber, Diffusoren und Reduzierringe für das SLV NUMINOS® Downlight System finden Sie auf den Seiten 48-51.

Dank der breiten Auswahl an Modulen gibt es für jede Anforderung die passende Lösung. Fix konfiguriert. Schnell und sicher installiert.



SPOTLIGHTS

- In drei Gehäusegrößen (65x155mm, 85x175mm, 100x203mm) mit Hochleistungs LED Modul in drei Lichtfarben (2700K, 3000K, 4000K) verfügbar.
- Durch den verbauten LED-Treiber (Phasendimmung, DALI) sind alle Spotlights für den direkten Anschluss an 230V Netzspannung geeignet.
- Wählbare Linsen mit Halbstreuwinkeln von 24°, 36° oder 60°.

SLV NUMINOS® Spotlights sind als schwenkbarer oder starrer Deckenspot, Pendelleuchte und als Spot für 3-Phasen Schienensysteme erhältlich.



Easy to install.

Weil sich Effizienz immer auszahlt, sind SLV Leuchten leicht, schnell und sicher zu installieren. So bietet der Anschluss via Montageplatte, Schienensystem, Schnellkupplung, Federbügel oder mit farbkodierten Treibern für Downlights einen entscheidenden Vorteil: Sie sparen Zeit Aufwand und damit auch Kosten.

EIN LEUCHTENSYSYSTEM.

Für alle Fälle.

Für Erfolg unter allen Bedingungen braucht es Teamplayer, die mit individuellen Stärken glänzen. Entdecken Sie, für welche Einsätze sich SLV NUMINOS® Leuchten besonders gut eignen.



Objekte zu einem
Hingucker machen.



SLV NUMINOS®
GIMBLE XS, DL
Art.-Nr.
1005817

Downlights.

Unauffällige, moderne und platzsparende Beleuchtung, die den Fokus auf Objekte oder den Raum lenkt: Die Downlights des SLV NUMINOS® Leuchtensystems sind in in gewerblichen und privaten Räumen variabel einsetzbar.



Für die elegante
Ausleuchtung von
Wohnbereichen.



SLV NUMINOS®
GIMBLE XS, DL
Art.-Nr.
1005843

Für Eingangsbe-
reiche, die Gäste
willkommen heißen.



SLV NUMINOS®
XS, DL
Art.-Nr.
1005520

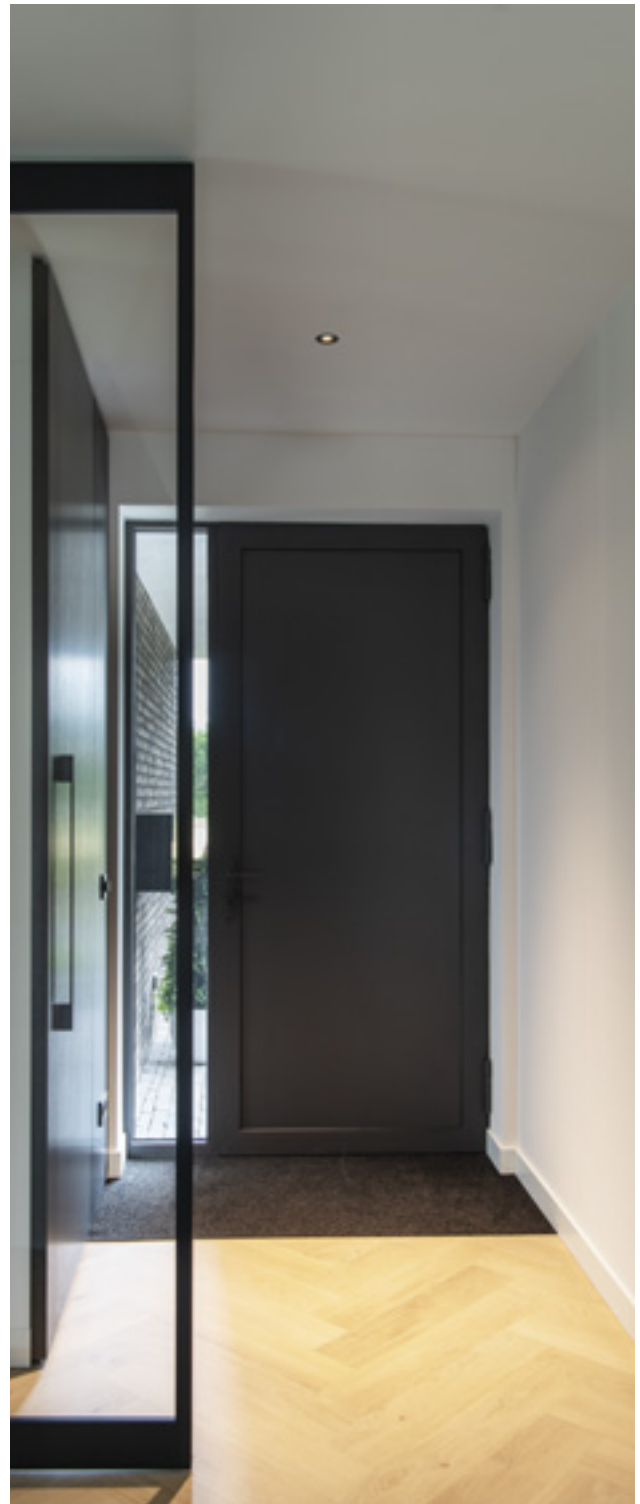

In Fluren den
Weg weisen.



SLV NUMINOS®
MOVE XS, DL
Art.-Nr.
1005584

Beleuchtung individuell gestalten.

Durch die große Auswahl an Reflektoren eignet sich das SLV NUMINOS® Leuchtensystem für die Akzentbeleuchtung wie auch zur Ausleuchtung von Produkten und Verkaufsflächen.

Um in Verkaufsräumen Akzente zu setzen.



SLV NUMINOS®
GIMBLE M, DL
Art.-Nr.
1005953



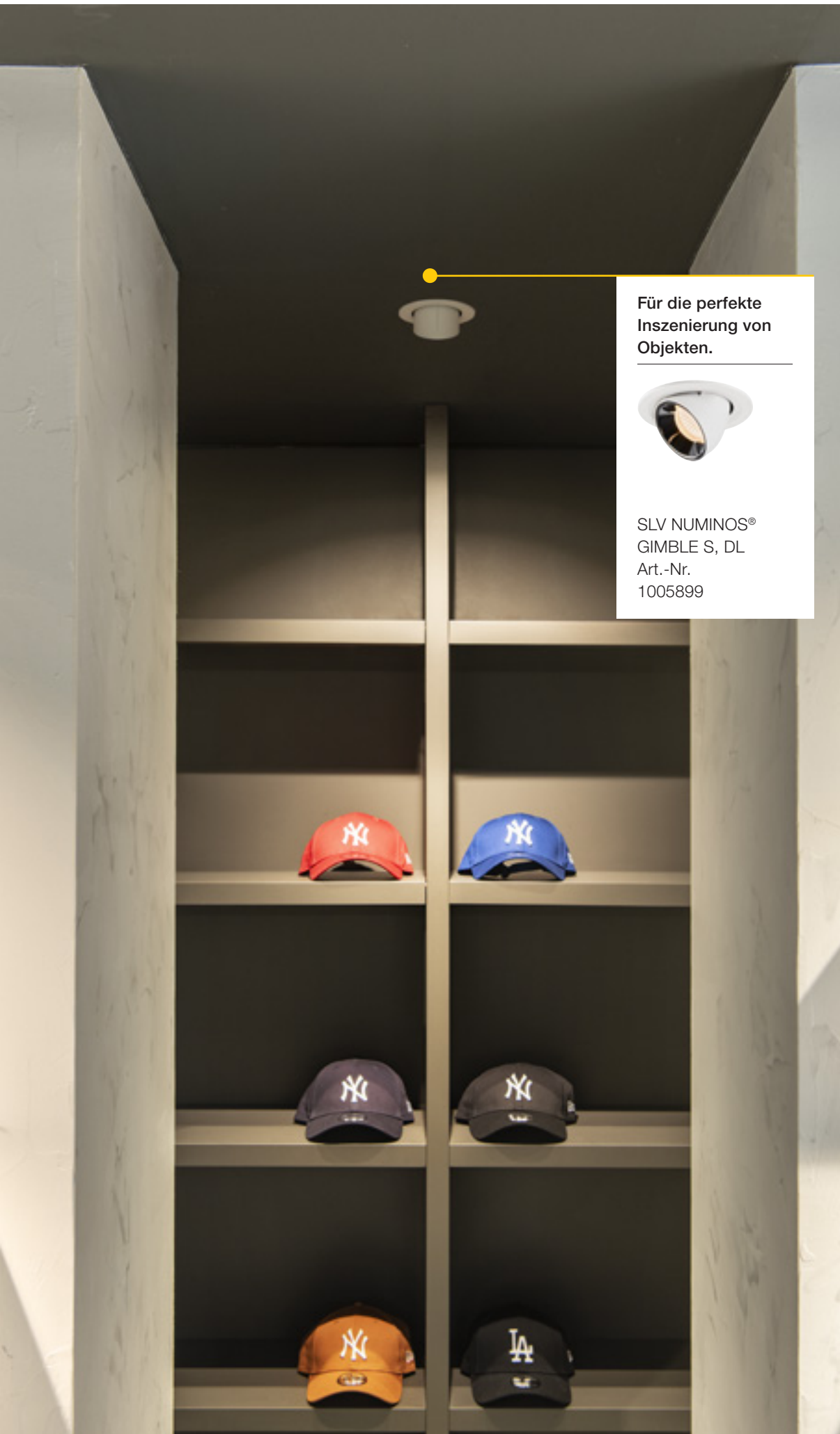

Für die perfekte
Inszenierung von
Objekten.



SLV NUMINOS®
GIMBLE S, DL
Art.-Nr.
1005899

Für eine flexible Ausleuchtung in alle Raumdimensionen.



SLV NUMINOS®
ZOOM M 3Ph.,
PHASE
Art.-Nr. 1006108

Produkte gekonnt in Szene setzen.



SLV NUMINOS®
ZOOM M
3Ph., DALI
Art.-Nr. 1006119

Spotlights.

In Shops und Boutiquen, aber auch in Restaurants, Bars, Museen, Studios, Praxen – in jedem Raum kommt es auf gekonnt gesetzte Akzente an. Spotlights sind sowohl für die Ausleuchtung größerer Flächen, als auch für die punktuelle Beleuchtung einsetzbar.





Um ein appetitanregendes Ambiente zu erschaffen.



SLV NUMINOS® M
PD, PHASE
Art.-Nr.
1004247
kombiniert
mit Zierring
Art.-Nr.
1006168

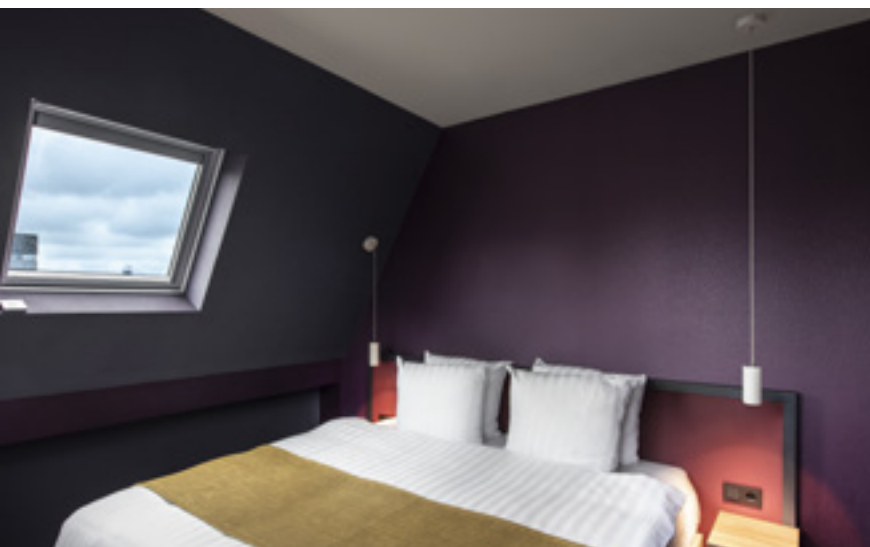

Für mehr Gemütlichkeit zu Hause.



SLV NUMINOS® S, PD, DALI
Art.-Nr. 1004439
kombiniert mit Zierring
Art.-Nr. 1006167



SYSTEMATISCH.

Zum Ziel.

Mit dem SLV NUMINOS® Online Konfigurator.

Nur drei Schritte und Sie sind am Ziel:

So einfach funktioniert der Konfigurator:

Die erste Frage lautet: Downlight oder Spotlight? Anschließend wählen Sie zwischen vorkonfigurierten und weiter anpassbaren Anwendungsszenarien oder der freien Konfiguration.

Falls Sie bei der Auswahl der Attribute noch unsicher sind, kein Problem: Zu jeder gewählten Konfiguration bieten wir Ihnen passende Erklärungen an.

Hier gelangen Sie zum SLV NUMINOS® Konfigurator:

www.numinos.slv.com

1 TECHNISCHE KONFIGURATION



2 OPTISCHE KONFIGURATION



3 VISUELLE DARSTELLUNG & ABSCHLUSS



Hier und jetzt zum Ziel – konfigurieren Sie Ihre Leuchte mit dem BIG WHITE®.

Stellen Sie Ihre Wunschleuchten auf den nächsten Seiten zusammen.

Die folgenden Produktübersichten bringen Sie ebenso leicht zum Ziel: Blättern Sie zum gewünschten Leuchtentyp, folgen Sie den Spalten von links nach rechts und treffen Sie dabei Ihre individuelle Auswahl. Am Ende steht die passende Artikelnummer zur direkten Bestellung bereit.

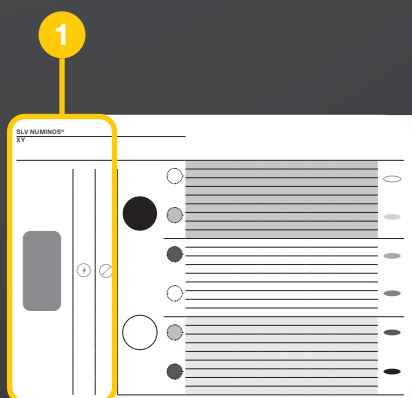

STEP 1

SPOTLIGHT ODER DOWNLIGHT?

Wählen Sie den passenden Leuchtentyp für Ihre Anforderung aus. Der Durchmesser (Downlights) bzw. die Gehäusegröße (Spotlights) sind dabei an die Systemleistung gekoppelt.

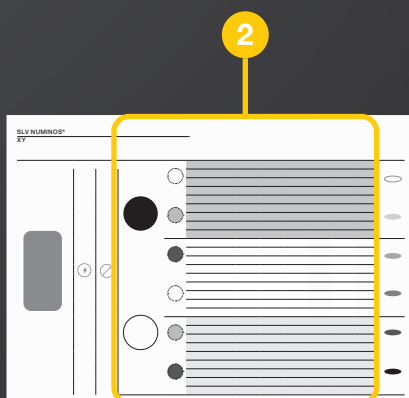

STEP 2

TECHNISCHE KONFIGURATION & DESIGN AUSWÄHLEN

Spalte für Spalte wählen Sie optische und technische Attribute wie Gehäuse- oder Dekoringfarben, die Farbtemperatur, Halbstreuwinkel und mehr aus.

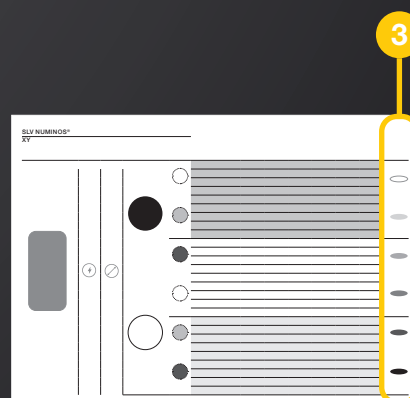

STEP 3

PRODUKT

Verschaffen Sie sich noch einen optischen Eindruck Ihrer fertig konfigurierten Leuchte, um sie gleich mit der passenden Artikelnummer zu bestellen.

NOCH ETWAS UNKLAR?

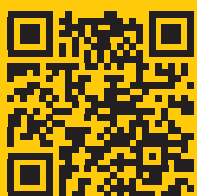

Scanne mich für ein Video, das anschaulich zeigt, wie einfach SLV NUMINOS® Leuchten zu konfigurieren sind.

Zusätzlich zu den bekannten Icons aus unserem Hauptkatalog BIG WHITE® finden Sie in diesem Kapitel folgende Icons:

 **Blendungsbewertung**

 **Farbtemperatur**

 **Halbstreuwinkel**

 **Lumen**

 **Steuerung**

SLV NUMINOS® XS



DL

XS



Produktangaben:

200mA

Leistungsaufnahme: 7W

Material: Aluminium / Polycarbonat (PC)

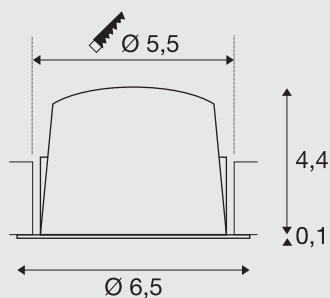

Hinweis:

Niederspannungsstecker

Treiber exkl.

Blattfedern liegen dem Produkt bei und können ausgetauscht werden.

Passende Treiber, Diffusoren und Reduzierringe finden Sie auf den Seiten 48-51.



schwarz

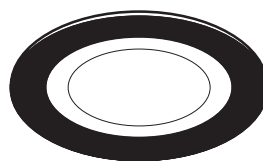

schwarz



weiß



chrom



schwarz

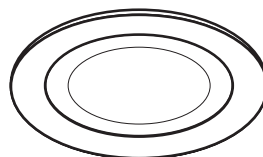

weiß



weiß



chrom



Blattfedern zur Installation
in massiven Decken liegen bei.



				ART. NR.	EUR	
2700K	640lm	20°	16	1005499	69,55	
	620lm	40°	22	1005502	69,55	
	640lm	55°	25	1005505	69,55	
3000K	700lm	20°	16	1005517	69,55	
	670lm	40°	22	1005520	69,55	
	690lm	55°	25	1005523	69,55	
4000K	720lm	20°	16	1005535	69,55	
	700lm	40°	22	1005538	69,55	
	710lm	55°	25	1005541	69,55	
2700K	670lm	20°	16	1005500	69,55	
	650lm	40°	22	1005503	69,55	
	670lm	55°	25	1005506	69,55	
3000K	730lm	20°	16	1005518	69,55	
	700lm	40°	22	1005521	69,55	
	720lm	55°	25	1005524	69,55	
4000K	750lm	20°	16	1005536	69,55	
	730lm	40°	22	1005539	69,55	
	740lm	55°	25	1005542	69,55	
2700K	670lm	20°	16	1005501	69,55	
	650lm	40°	22	1005504	69,55	
	670lm	55°	25	1005507	69,55	
3000K	730lm	20°	16	1005519	69,55	
	700lm	40°	22	1005522	69,55	
	720lm	55°	25	1005525	69,55	
4000K	750lm	20°	16	1005537	69,55	
	730lm	40°	22	1005540	69,55	
	740lm	55°	25	1005543	69,55	
2700K	640lm	20°	16	1005508	69,55	
	620lm	40°	22	1005511	69,55	
	640lm	55°	25	1005514	69,55	
3000K	700lm	20°	16	1005526	69,55	
	670lm	40°	22	1005529	69,55	
	690lm	55°	25	1005532	69,55	
4000K	720lm	20°	16	1005544	69,55	
	700lm	40°	22	1005547	69,55	
	710lm	55°	25	1005550	69,55	
2700K	670lm	20°	16	1005509	69,55	
	650lm	40°	22	1005512	69,55	
	670lm	55°	25	1005515	69,55	
3000K	730lm	20°	16	1005527	69,55	
	700lm	40°	22	1005530	69,55	
	720lm	55°	25	1005533	69,55	
4000K	750lm	20°	16	1005545	69,55	
	730lm	40°	22	1005548	69,55	
	740lm	55°	25	1005551	69,55	
2700K	670lm	20°	16	1005510	69,55	
	650lm	40°	22	1005513	69,55	
	670lm	55°	25	1005516	69,55	
3000K	730lm	20°	16	1005528	69,55	
	700lm	40°	22	1005531	69,55	
	720lm	55°	25	1005534	69,55	
4000K	750lm	20°	16	1005546	69,55	
	730lm	40°	22	1005549	69,55	
	740lm	55°	25	1005552	69,55	

SLV NUMINOS® S



DL

S



Produktangaben:

250mA

Leistungsaufnahme: 8,6W

Material: Aluminium / Polycarbonat (PC)

Einbaumaße: Ø: 6,8 cm T: 5,5 cm

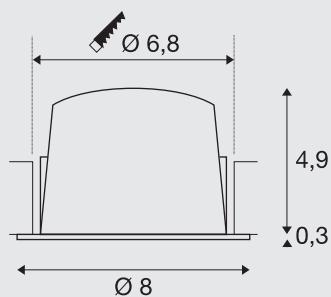

Hinweis:

Niederspannungsstecker

Treiber exkl.

Blattfedern liegen dem Produkt bei und können ausgetauscht werden.

Passende Treiber, Diffusoren und Reduzierringe finden Sie auf den Seiten 48-51.



schwarz

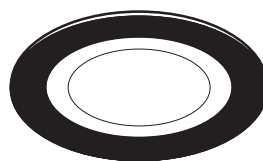

schwarz



weiß



chrom



schwarz

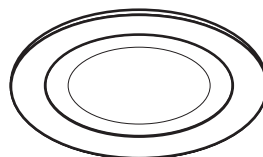

weiß



weiß



chrom



Blattfedern zur Installation
in massiven Decken liegen bei.



				ART. NR.	EUR	
2700K	670lm	20°	19	1003769	69,55	
	670lm	40°	18,5	1003772	69,55	
	670lm	55°	22	1003775	69,55	
3000K	690lm	20°	19	1003793	69,55	
	690lm	40°	19	1003796	69,55	
	690lm	55°	22	1003799	69,55	
4000K	730lm	20°	19	1003817	69,55	
	730lm	40°	19	1003820	69,55	
	730lm	55°	22	1003823	69,55	
2700K	720lm	20°	18,5	1003770	69,55	
	720lm	40°	19	1003773	69,55	
	720lm	55°	22	1003776	69,55	
3000K	730lm	20°	19	1003794	69,55	
	730lm	40°	19	1003797	69,55	
	730lm	55°	22	1003800	69,55	
4000K	790lm	20°	19	1003818	69,55	
	790lm	40°	19	1003821	69,55	
	790lm	55°	22	1003824	69,55	
2700K	690lm	20°	19	1003771	69,55	
	690lm	40°	19	1003774	69,55	
	690lm	55°	22	1003777	69,55	
3000K	700lm	20°	19	1003795	69,55	
	700lm	40°	19	1003798	69,55	
	700lm	55°	19	1003801	69,55	
4000K	750lm	20°	19	1003819	69,55	
	750lm	40°	19	1003822	69,55	
	750lm	55°	22	1003825	69,55	
2700K	670lm	20°	19	1003781	69,55	
	670lm	40°	19	1003784	69,55	
	670lm	55°	22	1003787	69,55	
3000K	690lm	20°	19	1003805	69,55	
	690lm	40°	19	1003808	69,55	
	690lm	55°	22	1003811	69,55	
4000K	730lm	20°	19	1003829	69,55	
	730lm	40°	19	1003832	69,55	
	730lm	55°	22	1003835	69,55	
2700K	720lm	20°	18,5	1003782	69,55	
	720lm	40°	19	1003785	69,55	
	720lm	55°	22	1003788	69,55	
3000K	730lm	20°	19	1003806	69,55	
	730lm	40°	19	1003809	69,55	
	730lm	55°	22	1003812	69,55	
4000K	790lm	20°	19	1003830	69,55	
	790lm	40°	19	1003833	69,55	
	790lm	55°	22	1003836	69,55	
2700K	690lm	20°	19	1003783	69,55	
	690lm	40°	19	1003786	69,55	
	690lm	55°	22	1003789	69,55	
3000K	700lm	20°	19	1003807	69,55	
	700lm	40°	19	1003810	69,55	
	700lm	55°	22	1003813	69,55	
4000K	750lm	20°	19	1003831	69,55	
	750lm	40°	19	1003834	69,55	
	750lm	55°	22	1003837	69,55	

SLV NUMINOS® M



DL

M



Produktangaben:

500mA

Leistungsaufnahme: 17,5W

Material: Aluminium / Polycarbonat (PC)

Einbaumaße: Ø: 9 cm T: 7,5 cm

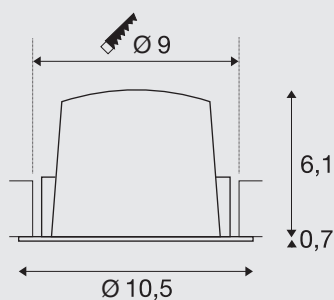

Hinweis:

Niederspannungsstecker

Treiber exkl.

Blattfedern liegen dem Produkt bei und können ausgetauscht werden.

Passende Treiber, Diffusoren und Reduzierringe finden Sie auf den Seiten 48-51.



schwarz

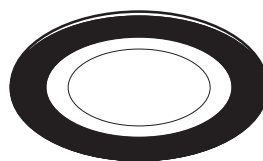

schwarz



weiß



chrom



schwarz

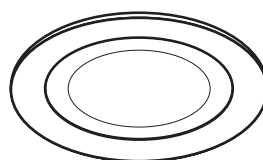

weiß



weiß



chrom



Blattfedern zur Installation
in massiven Decken liegen bei.



				ART. NR.	EUR	
2700K	1460lm	20°	19	1003841	83,46	
	1460lm	40°	22	1003844	83,46	
	1460lm	55°	22	1003847	83,46	
3000K	1500lm	20°	19	1003865	83,46	
	1500lm	40°	22	1003868	83,46	
	1500lm	55°	22	1003871	83,46	
4000K	1600lm	20°	19	1003889	83,46	
	1600lm	40°	22	1003892	83,46	
	1600lm	55°	22	1003895	83,46	
2700K	1600lm	20°	22	1003842	83,46	
	1600lm	40°	19,4	1003845	83,46	
	1600lm	55°	22	1003848	83,46	
3000K	1600lm	20°	22	1003866	83,46	
	1600lm	40°	22	1003869	83,46	
	1600lm	55°	22	1003872	83,46	
4000K	1750lm	20°	22	1003890	83,46	
	1750lm	40°	22	1003893	83,46	
	1750lm	55°	22	1003896	83,46	
2700K	1550lm	20°	19	1003843	83,46	
	1550lm	40°	19	1003846	83,46	
	1550lm	55°	19	1003849	83,46	
3000K	1550lm	20°	19	1003867	83,46	
	1550lm	40°	19	1003870	83,46	
	1550lm	55°	19	1003873	83,46	
4000K	1660lm	20°	19	1003891	83,46	
	1660lm	40°	19	1003894	83,46	
	1660lm	55°	19	1003897	83,46	
2700K	1460lm	20°	19	1003853	83,46	
	1460lm	40°	22	1003856	83,46	
	1460lm	55°	22	1003859	83,46	
3000K	1500lm	20°	19	1003877	83,46	
	1500lm	40°	22	1003880	83,46	
	1500lm	55°	22	1003883	83,46	
4000K	1600lm	20°	19	1003901	83,46	
	1600lm	40°	22	1003904	83,46	
	1600lm	55°	22	1003907	83,46	
2700K	1600lm	20°	22	1003854	83,46	
	1600lm	40°	19	1003857	83,46	
	1600lm	55°	22	1003860	83,46	
3000K	1600lm	20°	22	1003878	83,46	
	1600lm	40°	22	1003881	83,46	
	1600lm	55°	22	1003884	83,46	
4000K	1750lm	20°	22	1003902	83,46	
	1750lm	40°	22	1003905	83,46	
	1750lm	55°	22	1003908	83,46	
2700K	1550lm	20°	19	1003855	83,46	
	1550lm	40°	19	1003858	83,46	
	1550lm	55°	19	1003861	83,46	
3000K	1550lm	20°	19	1003879	83,46	
	1550lm	40°	19	1003882	83,46	
	1550lm	55°	19	1003885	83,46	
4000K	1660lm	20°	19	1003903	83,46	
	1660lm	40°	19	1003906	83,46	
	1660lm	55°	19	1003909	83,46	

SLV NUMINOS® L



DL



Produktangaben:

700mA

Leistungsaufnahme: 25,4W

Material: Aluminium / Polycarbonat (PC)

Einbaumaße: Ø: 11,7 cm T: 9 cm

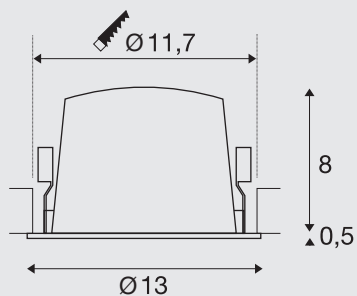

Hinweis:

Niederspannungsstecker

Treiber exkl.

Passende Treiber, Diffusoren und Reduzierringe finden Sie auf den Seiten 48-51.



schwarz

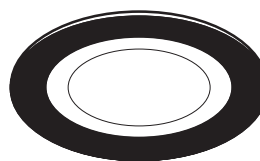

schwarz



weiß



chrom



schwarz

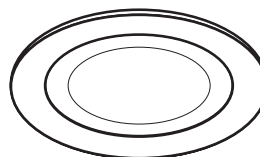

weiß



weiß



chrom

				ART. NR.	EUR	
2700K	2150lm	20°	22	1003913	101,65	
	2150lm	40°	22	1003916	101,65	
	2150lm	55°	22	1003919	101,65	
3000K	2150lm	20°	22	1003937	101,65	
	2150lm	40°	22	1003940	101,65	
	2150lm	55°	25	1003943	101,65	
4000K	2350lm	20°	22	1003961	101,65	
	2350lm	40°	22	1003964	101,65	
	2350lm	55°	25	1003967	101,65	
2700K	2250lm	20°	19	1003914	101,65	
	2250lm	40°	19	1003917	101,65	
	2250lm	55°	22	1003920	101,65	
3000K	2300lm	20°	19	1003938	101,65	
	2300lm	40°	19	1003941	101,65	
	2300lm	55°	20	1003944	101,65	
4000K	2450lm	20°	19	1003962	101,65	
	2450lm	40°	19	1003965	101,65	
	2450lm	55°	22	1003968	101,65	
2700K	2150lm	20°	19	1003915	101,65	
	2150lm	40°	19	1003918	101,65	
	2150lm	55°	19	1003921	101,65	
3000K	2200lm	20°	19	1003939	101,65	
	2200lm	40°	19	1003942	101,65	
	2200lm	55°	19	1003945	101,65	
4000K	2350lm	20°	19	1003963	101,65	
	2350lm	40°	19	1003966	101,65	
	2350lm	55°	19	1003969	101,65	
2700K	2150lm	20°	22	1003925	101,65	
	2150lm	40°	22	1003928	101,65	
	2150lm	55°	22	1003931	101,65	
3000K	2150lm	20°	22	1003949	101,65	
	2150lm	40°	22	1003952	101,65	
	2150lm	55°	25	1003955	101,65	
4000K	2350lm	20°	22	1003973	101,65	
	2350lm	40°	22	1003976	101,65	
	2350lm	55°	25	1003979	101,65	
2700K	2250lm	20°	19	1003926	101,65	
	2250lm	40°	19	1003929	101,65	
	2250lm	55°	22	1003932	101,65	
3000K	2300lm	20°	19	1003950	101,65	
	2300lm	40°	19	1003953	101,65	
	2300lm	55°	22	1003956	101,65	
4000K	2450lm	20°	19	1003974	101,65	
	2450lm	40°	19	1003977	101,65	
	2450lm	55°	22	1003980	101,65	
2700K	2150lm	20°	19	1003927	101,65	
	2150lm	40°	19	1003930	101,65	
	2150lm	55°	19	1003933	101,65	
3000K	2200lm	20°	19	1003951	101,65	
	2200lm	40°	19	1003954	101,65	
	2200lm	55°	19	1003957	101,65	
4000K	2350lm	20°	19	1003975	101,65	
	2350lm	40°	19	1003978	101,65	
	2350lm	55°	19	1003981	101,65	

SLV NUMINOS® XL



DL

XL



Produktangaben:

1050mA

Leistungsaufnahme: 37,4W

Material: Aluminium / Polycarbonat (PC)

Einbaumaße: Ø: 14,5 cm T: 11,5 cm

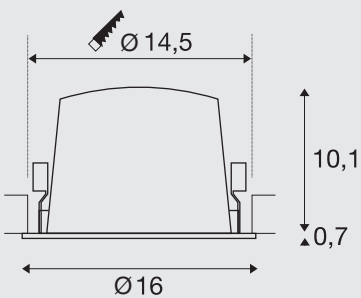

Hinweis:

Niederspannungsstecker

Treiber exkl.

Passende Treiber, Diffusoren und Reduzierringe finden Sie auf den Seiten 48-51.



schwarz

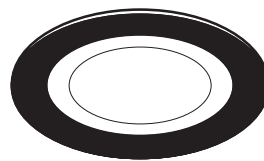

schwarz



weiß



chrom



schwarz

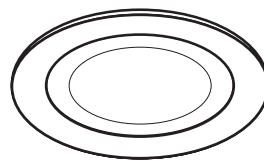

weiß



weiß



chrom

**ART. NR.****EUR**

2700K	3300lm	20°	22	1003985	126,26				
	3300lm	40°	22	1003988	126,26				
	3300lm	55°	22	1003991	126,26				
3000K	3300lm	20°	22	1004009	126,26				
	3300lm	40°	22	1004012	126,26				
	3300lm	55°	22	1004015	126,26				
4000K	3600lm	20°	22	1004033	126,26				
	3600lm	40°	22	1004036	126,26				
	3600lm	55°	25	1004039	126,26				
2700K	3500lm	20°	19	1003986	126,26				
	3500lm	40°	19	1003989	126,26				
	3500lm	55°	19	1003992	126,26				
3000K	3550lm	20°	19	1004010	126,26				
	3550lm	40°	19	1004013	126,26				
	3550lm	55°	19	1004016	126,26				
4000K	3800lm	20°	19	1004034	126,26				
	3800lm	40°	19	1004037	126,26				
	3800lm	55°	19	1004040	126,26				
2700K	3400lm	20°	19	1003987	126,26				
	3400lm	40°	19	1003990	126,26				
	3400lm	55°	19	1003993	126,26				
3000K	3500lm	20°	19	1004011	126,26				
	3500lm	40°	19	1004014	126,26				
	3500lm	55°	19	1004017	126,26				
4000K	3750lm	20°	19	1004035	126,26				
	3750lm	40°	19	1004038	126,26				
	3750lm	55°	19	1004041	126,26				
2700K	3300lm	20°	22	1003997	126,26				
	3300lm	40°	22	1004000	126,26				
	3300lm	55°	22	1004003	126,26				
3000K	3300lm	20°	22	1004021	126,26				
	3300lm	40°	22	1004024	126,26				
	3300lm	55°	22	1004027	126,26				
4000K	3600lm	20°	22	1004045	126,26				
	3600lm	40°	22	1004048	126,26				
	3600lm	55°	25	1004051	126,26				
2700K	3500lm	20°	19	1003998	126,26				
	3500lm	40°	19	1004001	126,26				
	3500lm	55°	19	1004004	126,26				
3000K	3550lm	20°	19	1004022	126,26				
	3550lm	40°	19	1004025	126,26				
	3550lm	55°	19	1004028	126,26				
4000K	3800lm	20°	19	1004046	126,26				
	3800lm	40°	19	1004049	126,26				
	3800lm	55°	19	1004052	126,26				
2700K	3400lm	20°	19	1003999	126,26				
	3400lm	40°	19	1004002	126,26				
	3400lm	55°	19	1004005	126,26				
3000K	3500lm	20°	19	1004023	126,26				
	3500lm	40°	19	1004026	126,26				
	3500lm	55°	19	1004029	126,26				
4000K	3750lm	20°	19	1004047	126,26				
	3750lm	40°	19	1004050	126,26				
	3750lm	55°	19	1004053	126,26				

SLV NUMINOS® MOVE XS



DL

XS



Produktangaben:

200mA

Leistungsaufnahme: 7W

Material: Aluminium / Polycarbonat (PC)

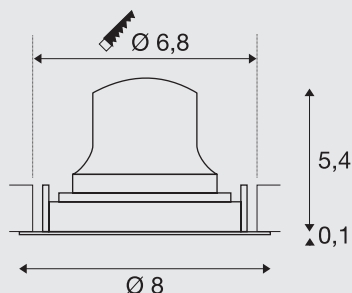

Hinweis:

Niederspannungsstecker
Treiber exkl.

Passende Treiber, Diffusoren und
Reduzierringe finden Sie auf den Seiten 48-51.



schwarz

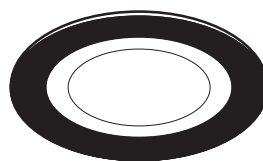

schwarz



weiß



chrom



schwarz

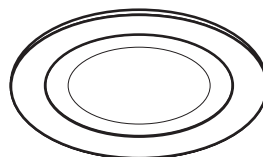











weiß



weiß



chrom

				ART. NR.	EUR		
2700K	640 lm	20°	16	1005553	80,25		
	620 lm	40°	22	1005556	80,25		
	640 lm	55°	25	1005559	80,25		
3000K	700 lm	20°	16	1005571	80,25		
	670 lm	40°	22	1005574	80,25		
	690 lm	55°	25	1005577	80,25		
4000K	720 lm	20°	16	1005589	80,25		
	700 lm	40°	22	1005592	80,25		
	710 lm	55°	25	1005595	80,25		
2700K	670 lm	20°	16	1005554	80,25		
	650 lm	40°	22	1005557	80,25		
	670 lm	55°	25	1005560	80,25		
3000K	730 lm	20°	16	1005572	80,25		
	700 lm	40°	22	1005575	80,25		
	720 lm	55°	25	1005578	80,25		
4000K	750 lm	20°	16	1005590	80,25		
	730 lm	40°	22	1005593	80,25		
	740 lm	55°	25	1005596	80,25		
2700K	670 lm	20°	16	1005555	80,25		
	650 lm	40°	22	1005558	80,25		
	670 lm	55°	25	1005561	80,25		
3000K	730 lm	20°	16	1005573	80,25		
	700 lm	40°	22	1005576	80,25		
	720 lm	55°	25	1005579	80,25		
4000K	750 lm	20°	16	1005591	80,25		
	730 lm	40°	22	1005594	80,25		
	740 lm	55°	25	1005597	80,25		
2700K	640 lm	20°	16	1005562	80,25		
	620 lm	40°	22	1005565	80,25		
	640 lm	55°	25	1005568	80,25		
3000K	700 lm	20°	16	1005580	80,25		
	670 lm	40°	22	1005583	80,25		
	690 lm	55°	25	1005586	80,25		
4000K	720 lm	20°	16	1005598	80,25		
	700 lm	40°	22	1005603	80,25		
	710 lm	55°	25	1005606	80,25		
2700K	670 lm	20°	16	1005563	80,25		
	650 lm	40°	22	1005566	80,25		
	670 lm	55°	25	1005569	80,25		
3000K	730 lm	20°	16	1005581	80,25		
	700 lm	40°	22	1005584	80,25		
	720 lm	55°	25	1005587	80,25		
4000K	750 lm	20°	16	1005599	80,25		
	730 lm	40°	22	1005604	80,25		
	740 lm	55°	25	1005607	80,25		
2700K	670 lm	20°	16	1005564	80,25		
	650 lm	40°	22	1005567	80,25		
	670 lm	55°	25	1005570	80,25		
3000K	730 lm	20°	16	1005582	80,25		
	700 lm	40°	22	1005585	80,25		
	720 lm	55°	25	1005588	80,25		
4000K	750 lm	20°	16	1005600	80,25		
	730 lm	40°	22	1005605	80,25		
	740 lm	55°	25	1005608	80,25		

SLV NUMINOS® MOVE S

DL



S



Produktangaben:

250 mA

Leistungsaufnahme: 8,6W

Material: Aluminium / Polycarbonat (PC)

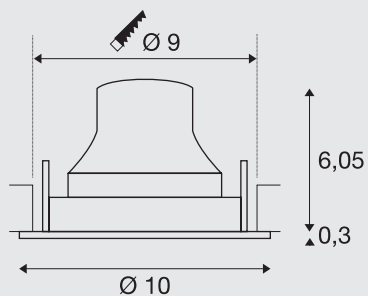

Hinweis:

Niederspannungsstecker
Treiber exkl.

Passende Treiber, Diffusoren und Reduzierringe finden Sie auf den Seiten 48-51.



schwarz

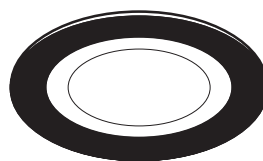

schwarz



weiß



chrom



schwarz

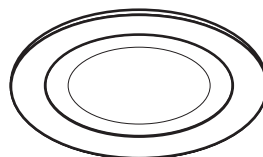

weiß



weiß



chrom

**ART. NR.****EUR**

2700K	670lm	20°	19	1005319	85,60			
	670lm	40°	19	1005322	85,60			
	670lm	55°	22	1005325	85,60			
3000K	690lm	20°	19	1005337	85,60			
	690lm	40°	19	1005340	85,60			
	690lm	55°	22	1005343	85,60			
4000K	730lm	20°	19	1005355	85,60			
	730lm	40°	19	1005358	85,60			
	730lm	55°	22	1005361	85,60			
2700K	720lm	20°	19	1005320	85,60			
	720lm	40°	19	1005323	85,60			
	720lm	55°	22	1005326	85,60			
3000K	730lm	20°	19	1005338	85,60			
	730lm	40°	19	1005341	85,60			
	730lm	55°	22	1005344	85,60			
4000K	790lm	20°	19	1005356	85,60			
	790lm	40°	19	1005359	85,60			
	790lm	55°	22	1005362	85,60			
2700K	690lm	20°	19	1005321	85,60			
	690lm	40°	19	1005324	85,60			
	690lm	55°	22	1005327	85,60			
3000K	700lm	20°	19	1005339	85,60			
	700lm	40°	19	1005342	85,60			
	700lm	55°	22	1005345	85,60			
4000K	750lm	20°	19	1005357	85,60			
	750lm	40°	19	1005360	85,60			
	750lm	55°	22	1005363	85,60			
2700K	670lm	20°	19	1005328	85,60			
	670lm	40°	19	1005331	85,60			
	670lm	55°	22	1005334	85,60			
3000K	690lm	20°	19	1005346	85,60			
	690lm	40°	19	1005349	85,60			
	690lm	55°	22	1005352	85,60			
4000K	730lm	20°	19	1005364	85,60			
	730lm	40°	19	1005367	85,60			
	730lm	55°	22	1005370	85,60			
2700K	720lm	20°	19	1005329	85,60			
	720lm	40°	19	1005332	85,60			
	720lm	55°	22	1005335	85,60			
3000K	730lm	20°	19	1005347	85,60			
	730lm	40°	19	1005350	85,60			
	730lm	55°	22	1005353	85,60			
4000K	790lm	20°	19	1005365	85,60			
	790lm	40°	19	1005368	85,60			
	790lm	55°	22	1005371	85,60			
2700K	690lm	20°	19	1005330	85,60			
	690lm	40°	19	1005333	85,60			
	690lm	55°	22	1005336	85,60			
3000K	700lm	20°	19	1005348	85,60			
	700lm	40°	19	1005351	85,60			
	700lm	55°	22	1005354	85,60			
4000K	750lm	20°	19	1005366	85,60			
	750lm	40°	19	1005369	85,60			
	750lm	55°	22	1005372	85,60			

SLV NUMINOS® MOVE M DL



M



Produktangaben:

500mA

Leistungsaufnahme: 17,5W

Material: Aluminium / Polycarbonat (PC)

Einbaumaße: Ø: 12 cm T: 10 cm

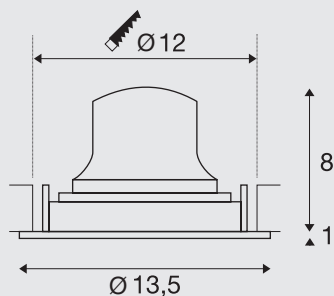

Hinweis:

Niederspannungsstecker

Treiber exkl.

Passende Treiber, Diffusoren und Reduzierringe finden Sie auf den Seiten 48-51.



schwarz

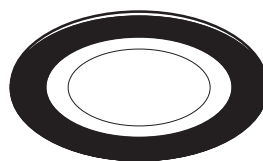

schwarz



weiß



chrom



schwarz

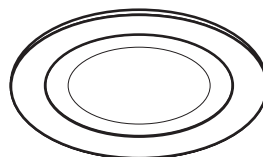





weiß



weiß



chrom

				ART. NR.	EUR	
2700K	1460lm	20°	19	1003553	96,30	
	1460lm	40°	22	1003556	96,30	
	1460lm	55°	22	1003559	96,30	
3000K	1500lm	20°	19	1003577	96,30	
	1500lm	40°	22	1003580	96,30	
	1500lm	55°	22	1003583	96,30	
4000K	1600lm	20°	19	1003601	96,30	
	1600lm	40°	22	1003604	96,30	
	1600lm	55°	22	1003607	96,30	
2700K	1600lm	20°	22	1003554	96,30	
	1600lm	40°	19	1003557	96,30	
	1600lm	55°	22	1003560	96,30	
3000K	1600lm	20°	22	1003578	96,30	
	1600lm	40°	22	1003581	96,30	
	1600lm	55°	22	1003584	96,30	
4000K	1750lm	20°	22	1003602	96,30	
	1750lm	40°	22	1003605	96,30	
	1750lm	55°	22	1003608	96,30	
2700K	1550lm	20°	19	1003555	96,30	
	1550lm	40°	19	1003558	96,30	
	1550lm	55°	19	1003561	96,30	
3000K	1550lm	20°	19	1003579	96,30	
	1550lm	40°	19	1003582	96,30	
	1550lm	55°	19	1003585	96,30	
4000K	1660lm	20°	19	1003603	96,30	
	1660lm	40°	19	1003606	96,30	
	1660lm	55°	19	1003609	96,30	
2700K	1460lm	20°	19	1003565	96,30	
	1460lm	40°	22	1003568	96,30	
	1460lm	55°	22	1003571	96,30	
3000K	1500lm	20°	19	1003589	96,30	
	1500lm	40°	22	1003592	96,30	
	1500lm	55°	22	1003595	96,30	
4000K	1600lm	20°	19	1003613	96,30	
	1600lm	40°	22	1003616	96,30	
	1600lm	55°	22	1003619	96,30	
2700K	1600lm	20°	22	1003566	96,30	
	1600lm	40°	22	1003569	96,30	
	1600lm	55°	22	1003572	96,30	
3000K	1600lm	20°	22	1003590	96,30	
	1600lm	40°	22	1003593	96,30	
	1600lm	55°	22	1003596	96,30	
4000K	1750lm	20°	22	1003614	96,30	
	1750lm	40°	22	1003617	96,30	
	1750lm	55°	22	1003620	96,30	
2700K	1550lm	20°	19	1003567	96,30	
	1550lm	40°	19	1003570	96,30	
	1550lm	55°	19	1003573	96,30	
3000K	1550lm	20°	19	1003591	96,30	
	1550lm	40°	19	1003594	96,30	
	1550lm	55°	19	1003597	96,30	
4000K	1660lm	20°	19	1003615	96,30	
	1660lm	40°	19	1003618	96,30	
	1660lm	55°	19	1003621	96,30	

SLV NUMINOS® MOVE L DL



Produktangaben:

750mA

Leistungsaufnahme: 25,4W

Material: Aluminium / Polycarbonat (PC)

Einbaumaße: Ø: 14,5 cm T: 10,5 cm

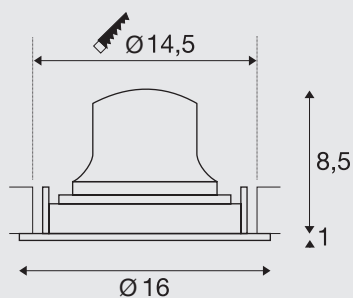

Hinweis:

Niederspannungsstecker
Treiber exkl.

Passende Treiber, Diffusoren und
Reduzierringe finden Sie auf den Seiten 48-51.



■ schwarz

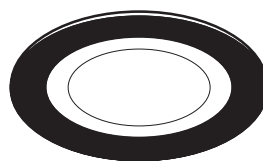

■ schwarz



□ weiß



■ chrom



■ schwarz

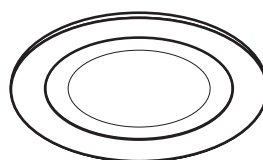

□ weiß



□ weiß



■ chrom

				ART. NR.	EUR		
2700K	2150lm	20°	22	1003625	112,35		
	2150lm	40°	22	1003628	112,35		
	2150lm	55°	22	1003631	112,35		
3000K	2150lm	20°	22	1003649	112,35		
	2150lm	40°	22	1003652	112,35		
	2150lm	55°	25	1003655	112,35		
4000K	2350lm	20°	22	1003673	112,35		
	2350lm	40°	22	1003676	112,35		
	2350lm	55°	25	1003679	112,35		
2700K	2250lm	20°	19	1003626	112,35		
	2250lm	40°	19	1003629	112,35		
	2250lm	55°	22	1003632	112,35		
3000K	2300lm	20°	19	1003650	112,35		
	2300lm	40°	19	1003653	112,35		
	2300lm	55°	22	1003656	112,35		
4000K	2450lm	20°	19	1003674	112,35		
	2450lm	40°	19	1003677	112,35		
	2450lm	55°	22	1003680	112,35		
2700K	2150lm	20°	19	1003627	112,35		
	2150lm	40°	19	1003630	112,35		
	2150lm	55°	19	1003633	112,35		
3000K	2200lm	20°	19	1003651	112,35		
	2200lm	40°	19	1003654	112,35		
	2200lm	55°	19	1003657	112,35		
4000K	2350lm	20°	19	1003675	112,35		
	2350lm	40°	19	1003678	112,35		
	2350lm	55°	19	1003681	112,35		
2700K	2150lm	20°	22	1003637	112,35		
	2150lm	40°	22	1003640	112,35		
	2150lm	55°	22	1003643	112,35		
3000K	2150lm	20°	22	1003661	112,35		
	2150lm	40°	22	1003664	112,35		
	2150lm	55°	25	1003667	112,35		
4000K	2350lm	20°	22	1003685	112,35		
	2350lm	40°	22	1003688	112,35		
	2350lm	55°	25	1003691	112,35		
2700K	2250lm	20°	19	1003638	112,35		
	2250lm	40°	19	1003641	112,35		
	2250lm	55°	22	1003644	112,35		
3000K	2300lm	20°	19	1003662	112,35		
	2300lm	40°	19	1003665	112,35		
	2300lm	55°	22	1003668	112,35		
4000K	2450lm	20°	19	1003686	112,35		
	2450lm	40°	19	1003689	112,35		
	2450lm	55°	22	1003692	112,35		
2700K	2150lm	20°	19	1003639	112,35		
	2150lm	40°	19	1003642	112,35		
	2150lm	55°	19	1003645	112,35		
3000K	2200lm	20°	19	1003663	112,35		
	2200lm	40°	19	1003666	112,35		
	2200lm	55°	19	1003669	112,35		
4000K	2350lm	20°	19	1003687	112,35		
	2350lm	40°	19	1003690	112,35		
	2350lm	55°	19	1003693	112,35		

SLV NUMINOS® MOVE XL



DL

XL



Produktangaben:

1050mA

Leistungsaufnahme: 37,4W

Material: Aluminium / Polycarbonat (PC)

Einbaumaße: Ø: 17,5 cm T: 13 cm

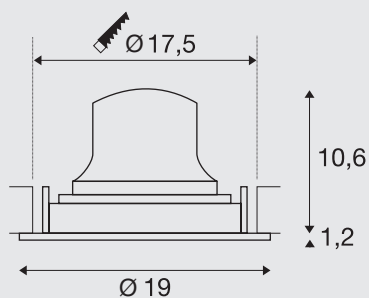

Hinweis:

Niederspannungsstecker

Treiber exkl.

Passende Treiber, Diffusoren und Reduzierringe finden Sie auf den Seiten 48-51.



schwarz

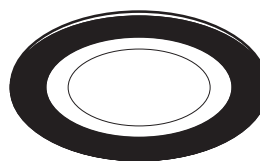

schwarz



weiß



chrom



schwarz

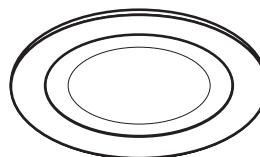

weiß



weiß



chrom

				ART. NR.	EUR	
2700K	3300lm	20°	22	1003697	146,59	
	3300lm	40°	22	1003700	146,59	
	3300lm	55°	22	1003703	146,59	
3000K	3300lm	20°	22	1003721	146,59	
	3300lm	40°	22	1003724	146,59	
	3300lm	55°	22	1003727	146,59	
4000K	3600lm	20°	22	1003745	146,59	
	3600lm	40°	22	1003748	146,59	
	3600lm	55°	25	1003751	146,59	
2700K	3500lm	20°	19	1003698	146,59	
	3500lm	40°	19	1003701	146,59	
	3500lm	55°	19	1003704	146,59	
3000K	3550lm	20°	19	1003722	146,59	
	3550lm	40°	19	1003725	146,59	
	3550lm	55°	19	1003728	146,59	
4000K	3800lm	20°	19	1003746	146,59	
	3800lm	40°	19	1003749	146,59	
	3800lm	55°	19	1003752	146,59	
2700K	3400lm	20°	19	1003699	146,59	
	3400lm	40°	19	1003702	146,59	
	3400lm	55°	19	1003705	146,59	
3000K	3500lm	20°	19	1003723	146,59	
	3500lm	40°	19	1003726	146,59	
	3500lm	55°	19	1003729	146,59	
4000K	3750lm	20°	19	1003747	146,59	
	3750lm	40°	19	1003750	146,59	
	3750lm	55°	19	1003753	146,59	
2700K	3300lm	20°	22	1003709	146,59	
	3300lm	40°	22	1003712	146,59	
	3300lm	55°	22	1003715	146,59	
3000K	3300lm	20°	22	1003733	146,59	
	3300lm	40°	22	1003736	146,59	
	3300lm	55°	22	1003739	146,59	
4000K	3600lm	20°	22	1003757	146,59	
	3600lm	40°	22	1003760	146,59	
	3600lm	55°	25	1003763	146,59	
2700K	3500lm	20°	19	1003710	146,59	
	3500lm	40°	19	1003713	146,59	
	3500lm	55°	19	1003716	146,59	
3000K	3550lm	20°	19	1003734	146,59	
	3550lm	40°	19	1003737	146,59	
	3550lm	55°	19	1003740	146,59	
4000K	3800lm	20°	19	1003758	146,59	
	3800lm	40°	19	1003761	146,59	
	3800lm	55°	19	1003764	146,59	
2700K	3400lm	20°	19	1003711	146,59	
	3400lm	40°	19	1003714	146,59	
	3400lm	55°	19	1003717	146,59	
3000K	3500lm	20°	19	1003735	146,59	
	3500lm	40°	19	1003738	146,59	
	3500lm	55°	19	1003741	146,59	
4000K	3750lm	20°	19	1003759	146,59	
	3750lm	40°	19	1003762	146,59	
	3750lm	55°	19	1003765	146,59	

SLV NUMINOS® GIMBLE XS

DL



XS



Produktangaben:

200mA

Leistungsaufnahme: 7W

Material: Aluminium / Polycarbonat (PC)

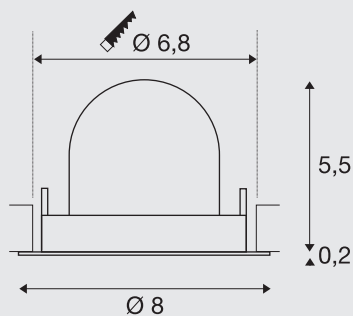
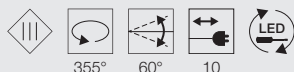

Hinweis:

Niederspannungsstecker
Treiber exkl.

Passende Treiber, Diffusoren und Reduzierringe finden Sie auf den Seiten 48-51.



■ schwarz

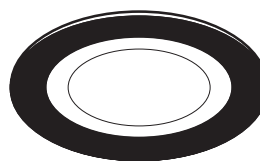

■ schwarz



□ weiß



■ chrom



■ schwarz

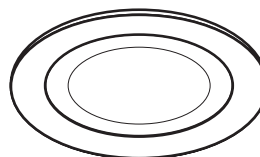







□ weiß



□ weiß



■ chrom

				ART. NR.	EUR	
2700K	640lm	20°	16	1005813	85,60	
	620lm	40°	22	1005816	85,60	
	640lm	55°	25	1005819	85,60	
3000K	700lm	20°	16	1005831	85,60	
	670lm	40°	22	1005834	85,60	
	690lm	55°	25	1005837	85,60	
4000K	720lm	20°	16	1005849	85,60	
	700lm	40°	22	1005852	85,60	
	710lm	55°	25	1005855	85,60	
2700K	670lm	20°	16	1005814	85,60	
	650lm	40°	22	1005817	85,60	
	670lm	55°	25	1005820	85,60	
3000K	730lm	20°	16	1005832	85,60	
	700lm	40°	22	1005835	85,60	
	720lm	55°	25	1005838	85,60	
4000K	750lm	20°	16	1005850	85,60	
	730lm	40°	22	1005853	85,60	
	740lm	55°	25	1005856	85,60	
2700K	670lm	20°	16	1005815	85,60	
	650lm	40°	22	1005818	85,60	
	670lm	55°	25	1005821	85,60	
3000K	730lm	20°	16	1005833	85,60	
	700lm	40°	22	1005836	85,60	
	720lm	55°	25	1005839	85,60	
4000K	750lm	20°	16	1005851	85,60	
	730lm	40°	22	1005854	85,60	
	740lm	55°	25	1005857	85,60	
2700K	640lm	20°	16	1005822	85,60	
	620lm	40°	22	1005825	85,60	
	640lm	55°	25	1005828	85,60	
3000K	700lm	20°	16	1005840	85,60	
	670lm	40°	22	1005843	85,60	
	690lm	55°	25	1005846	85,60	
4000K	720lm	20°	16	1005858	85,60	
	700lm	40°	22	1005861	85,60	
	710lm	55°	25	1005864	85,60	
2700K	670lm	20°	16	1005823	85,60	
	650lm	40°	22	1005826	85,60	
	670lm	55°	25	1005829	85,60	
3000K	730lm	20°	16	1005841	85,60	
	700lm	40°	22	1005844	85,60	
	720lm	55°	25	1005847	85,60	
4000K	750lm	20°	16	1005859	85,60	
	730lm	40°	22	1005862	85,60	
	740lm	55°	25	1005865	85,60	
2700K	670lm	20°	16	1005824	85,60	
	650lm	40°	22	1005827	85,60	
	670lm	55°	25	1005830	85,60	
3000K	730lm	20°	16	1005842	85,60	
	700lm	40°	22	1005845	85,60	
	720lm	55°	25	1005848	85,60	
4000K	750lm	20°	16	1005860	85,60	
	730lm	40°	22	1005863	85,60	
	740lm	55°	25	1005866	85,60	

SLV NUMINOS® GIMBLE S DL



S



Produktangaben:

250mA

Leistungsaufnahme: 8,6 W

Material: Aluminium / Polycarbonat (PC)

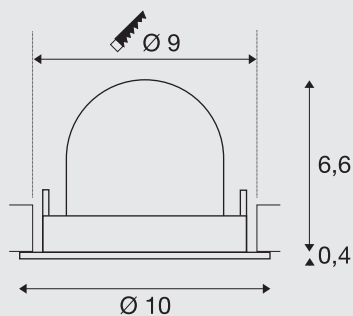
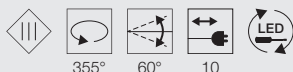

Hinweis:

Niederspannungsstecker
Treiber exkl.

Passende Treiber, Diffusoren und
Reduzierringe finden Sie auf den Seiten 48-51.



■ schwarz

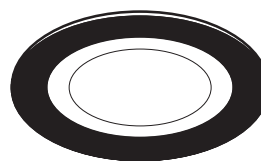

■ schwarz



□ weiß



■ chrom



■ schwarz

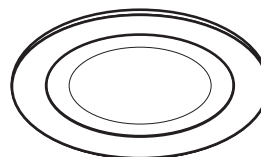











□ weiß



□ weiß



■ chrom

				ART. NR.	EUR	
2700K	670lm	20°	19	1005867	90,95	
	670lm	40°	19	1005870	90,95	
	670lm	55°	22	1005873	90,95	
3000K	690lm	20°	19	1005885	90,95	
	690lm	40°	19	1005888	90,95	
	690lm	55°	22	1005891	90,95	
4000K	730lm	20°	19	1005903	90,95	
	730lm	40°	19	1005906	90,95	
	730lm	55°	22	1005909	90,95	
2700K	720lm	20°	19	1005868	90,95	
	720lm	40°	19	1005871	90,95	
	720lm	55°	22	1005874	90,95	
3000K	730lm	20°	19	1005886	90,95	
	730lm	40°	19	1005889	90,95	
	730lm	55°	22	1005892	90,95	
4000K	790lm	20°	19	1005904	90,95	
	790lm	40°	19	1005907	90,95	
	790lm	55°	22	1005910	90,95	
2700K	690lm	20°	19	1005869	90,95	
	690lm	40°	19	1005872	90,95	
	690lm	55°	22	1005875	90,95	
3000K	700lm	20°	19	1005887	90,95	
	700lm	40°	19	1005890	90,95	
	700lm	55°	22	1005893	90,95	
4000K	750lm	20°	19	1005905	90,95	
	750lm	40°	19	1005908	90,95	
	750lm	55°	22	1005911	90,95	
2700K	670lm	20°	19	1005876	90,95	
	670lm	40°	19	1005879	90,95	
	670lm	55°	22	1005882	90,95	
3000K	690lm	20°	19	1005894	90,95	
	690lm	40°	19	1005897	90,95	
	690lm	55°	22	1005900	90,95	
4000K	730lm	20°	19	1005912	90,95	
	730lm	40°	19	1005915	90,95	
	730lm	55°	22	1005918	90,95	
2700K	720lm	20°	19	1005877	90,95	
	720lm	40°	19	1005880	90,95	
	720lm	55°	22	1005883	90,95	
3000K	730lm	20°	19	1005895	90,95	
	730lm	40°	19	1005898	90,95	
	730lm	55°	22	1005901	90,95	
4000K	790lm	20°	19	1005913	90,95	
	790lm	40°	19	1005916	90,95	
	790lm	55°	22	1005919	90,95	
2700K	690lm	20°	19	1005878	90,95	
	690lm	40°	19	1005881	90,95	
	690lm	55°	22	1005884	90,95	
3000K	700lm	20°	19	1005896	90,95	
	700lm	40°	19	1005899	90,95	
	700lm	55°	22	1005902	90,95	
4000K	750lm	20°	19	1005914	90,95	
	750lm	40°	19	1005917	90,95	
	750lm	55°	22	1005920	90,95	

SLV NUMINOS® GIMBLE M DL



M



Produktangaben:

500mA

Leistungsaufnahme: 17,5W

Material: Aluminium / Polycarbonat (PC)

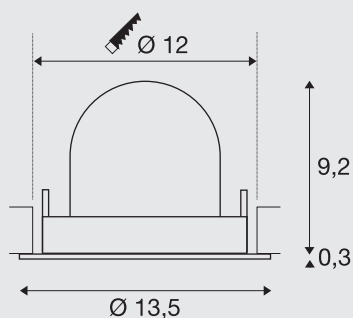
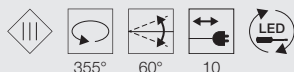

Hinweis:

Niederspannungsstecker
Treiber exkl.

Passende Treiber, Diffusoren und
Reduzierringe finden Sie auf den Seiten 48-51.



schwarz

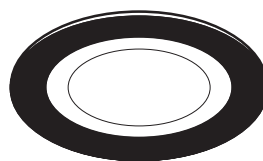

schwarz



weiß



chrom



schwarz

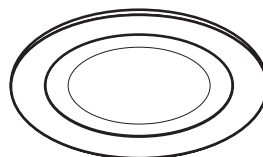



weiß



weiß



chrom

				ART. NR.	EUR	
2700K	1460lm	20°	22	1005921	101,65	
	1460lm	40°	22	1005924	101,65	
	1460lm	55°	22	1005927	101,65	
3000K	1500lm	20°	22	1005939	101,65	
	1500lm	40°	22	1005942	101,65	
	1500lm	55°	22	1005945	101,65	
4000K	1600lm	20°	22	1005957	101,65	
	1600lm	40°	22	1005960	101,65	
	1600lm	55°	22	1005963	101,65	
2700K	1600lm	20°	22	1005922	101,65	
	1600lm	40°	22	1005925	101,65	
	1600lm	55°	22	1005928	101,65	
3000K	1600lm	20°	22	1005940	101,65	
	1600lm	40°	22	1005943	101,65	
	1600lm	55°	22	1005946	101,65	
4000K	1750lm	20°	22	1005958	101,65	
	1750lm	40°	22	1005961	101,65	
	1750lm	55°	22	1005964	101,65	
2700K	1550lm	20°	22	1005923	101,65	
	1550lm	40°	22	1005926	101,65	
	1550lm	55°	22	1005929	101,65	
3000K	1550lm	20°	22	1005941	101,65	
	1550lm	40°	22	1005944	101,65	
	1550lm	55°	22	1005947	101,65	
4000K	1660lm	20°	22	1005959	101,65	
	1660lm	40°	22	1005962	101,65	
	1660lm	55°	22	1005965	101,65	
2700K	1460lm	20°	22	1005930	101,65	
	1460lm	40°	22	1005933	101,65	
	1460lm	55°	22	1005936	101,65	
3000K	1500lm	20°	22	1005948	101,65	
	1500lm	40°	22	1005951	101,65	
	1500lm	55°	22	1005954	101,65	
4000K	1600lm	20°	22	1005966	101,65	
	1600lm	40°	22	1005969	101,65	
	1600lm	55°	22	1005972	101,65	
2700K	1600lm	20°	22	1005931	101,65	
	1600lm	40°	22	1005934	101,65	
	1600lm	55°	22	1005937	101,65	
3000K	1600lm	20°	22	1005949	101,65	
	1600lm	40°	22	1005952	101,65	
	1600lm	55°	22	1005955	101,65	
4000K	1750lm	20°	22	1005967	101,65	
	1750lm	40°	22	1005970	101,65	
	1750lm	55°	22	1005973	101,65	
2700K	1550lm	20°	22	1005932	101,65	
	1550lm	40°	22	1005935	101,65	
	1550lm	55°	22	1005938	101,65	
3000K	1550lm	20°	22	1005950	101,65	
	1550lm	40°	22	1005953	101,65	
	1550lm	55°	22	1005956	101,65	
4000K	1660lm	20°	22	1005968	101,65	
	1660lm	40°	22	1005971	101,65	
	1660lm	55°	22	1005974	101,65	

SLV NUMINOS® GIMBLE L DL



Produktangaben:

700mA

Leistungsaufnahme: 25,4W

Material: Aluminium / Polycarbonat (PC)

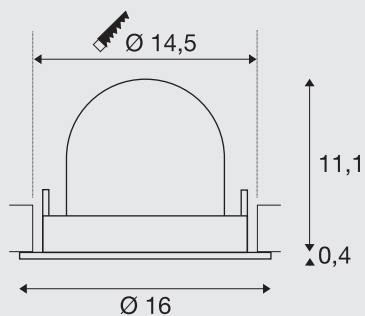
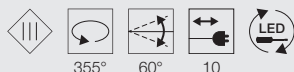

Hinweis:

Niederspannungsstecker
Treiber exkl.

Passende Treiber, Diffusoren und
Reduzierringe finden Sie auf den Seiten 48-51.



schwarz

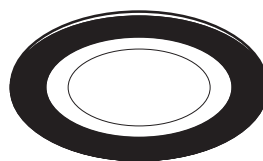

schwarz



weiß



chrom



schwarz

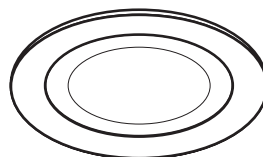











weiß



weiß



chrom

				ART. NR.	EUR	
2700K	2150lm	20°	22	1005975	112,35	
	2150lm	40°	22	1005978	112,35	
	2150lm	55°	22	1005981	112,35	
3000K	2150lm	20°	22	1005993	112,35	
	2150lm	40°	22	1005996	112,35	
	2150lm	55°	22	1005999	112,35	
4000K	2350lm	20°	22	1006011	112,35	
	2350lm	40°	22	1006014	112,35	
	2350lm	55°	22	1006017	112,35	
2700K	2250lm	20°	22	1005976	112,35	
	2250lm	40°	22	1005979	112,35	
	2250lm	55°	22	1005982	112,35	
3000K	2300lm	20°	22	1005994	112,35	
	2300lm	40°	22	1005997	112,35	
	2300lm	55°	22	1006000	112,35	
4000K	2450lm	20°	22	1006012	112,35	
	2450lm	40°	22	1006015	112,35	
	2450lm	55°	22	1006018	112,35	
2700K	2150lm	20°	22	1005977	112,35	
	2150lm	40°	22	1005980	112,35	
	2150lm	55°	22	1005983	112,35	
3000K	2200lm	20°	22	1005995	112,35	
	2200lm	40°	22	1005998	112,35	
	2200lm	55°	22	1006001	112,35	
4000K	2350lm	20°	22	1006013	112,35	
	2350lm	40°	22	1006016	112,35	
	2350lm	55°	22	1006019	112,35	
2700K	2150lm	20°	22	1005984	112,35	
	2150lm	40°	22	1005987	112,35	
	2150lm	55°	22	1005990	112,35	
3000K	2150lm	20°	22	1006002	112,35	
	2150lm	40°	22	1006005	112,35	
	2150lm	55°	22	1006008	112,35	
4000K	2350lm	20°	22	1006020	112,35	
	2350lm	40°	22	1006023	112,35	
	2350lm	55°	22	1006026	112,35	
2700K	2250lm	20°	22	1005985	112,35	
	2250lm	40°	22	1005988	112,35	
	2250lm	55°	22	1005991	112,35	
3000K	2300lm	20°	22	1006003	112,35	
	2300lm	40°	22	1006006	112,35	
	2300lm	55°	22	1006009	112,35	
4000K	2450lm	20°	22	1006021	112,35	
	2450lm	40°	22	1006024	112,35	
	2450lm	55°	22	1006027	112,35	
2700K	2150lm	20°	22	1005986	112,35	
	2150lm	40°	22	1005989	112,35	
	2150lm	55°	22	1005992	112,35	
3000K	2200lm	20°	22	1006004	112,35	
	2200lm	40°	22	1006007	112,35	
	2200lm	55°	22	1006010	112,35	
4000K	2350lm	20°	22	1006022	112,35	
	2350lm	40°	22	1006025	112,35	
	2350lm	55°	22	1006028	112,35	

SLV NUMINOS® GIMBLE XL



DL

XL



Produktangaben:

1000/1050mA

Leistungsaufnahme: 37,4W

Material: Aluminium / Polycarbonat (PC)

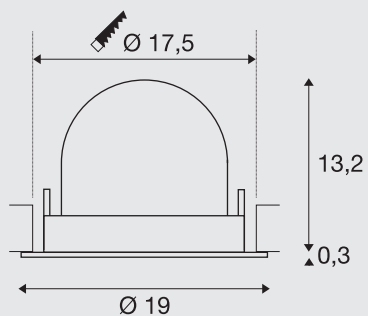
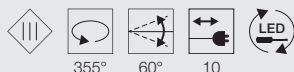

Hinweis:

Niederspannungsstecker
Treiber exkl.

Passende Treiber, Diffusoren und
Reduzierringe finden Sie auf den Seiten 48-51.



schwarz

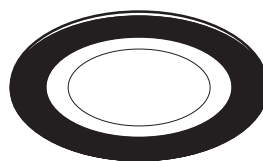

schwarz



weiß



chrom



schwarz

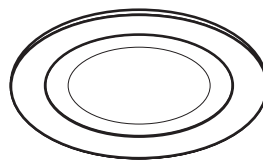











weiß



weiß



chrom

				ART. NR.	EUR	
2700K	3300lm	20°	22	1006029	133,75	
	3300lm	40°	22	1006032	133,75	
	3300lm	55°	22	1006035	133,75	
3000K	3300lm	20°	22	1006047	133,75	
	3300lm	40°	22	1006050	133,75	
	3300lm	55°	22	1006053	133,75	
4000K	3600lm	20°	22	1006065	133,75	
	3600lm	40°	22	1006068	133,75	
	3600lm	55°	22	1006071	133,75	
2700K	3500lm	20°	22	1006030	133,75	
	3500lm	40°	22	1006033	133,75	
	3500lm	55°	22	1006036	133,75	
3000K	3550lm	20°	22	1006048	133,75	
	3550lm	40°	22	1006051	133,75	
	3550lm	55°	22	1006054	133,75	
4000K	3800lm	20°	22	1006066	133,75	
	3800lm	40°	22	1006069	133,75	
	3800lm	55°	22	1006072	133,75	
2700K	3400lm	20°	22	1006031	133,75	
	3400lm	40°	22	1006034	133,75	
	3400lm	55°	22	1006037	133,75	
3000K	3500lm	20°	22	1006049	133,75	
	3500lm	40°	22	1006052	133,75	
	3500lm	55°	22	1006055	133,75	
4000K	3750lm	20°	22	1006067	133,75	
	3750lm	40°	22	1006070	133,75	
	3750lm	55°	22	1006073	133,75	
2700K	3300lm	20°	22	1006038	133,75	
	3300lm	40°	22	1006041	133,75	
	3300lm	55°	22	1006044	133,75	
3000K	3300lm	20°	22	1006056	133,75	
	3300lm	40°	22	1006059	133,75	
	3300lm	55°	22	1006062	133,75	
4000K	3600lm	20°	22	1006074	133,75	
	3600lm	40°	22	1006077	133,75	
	3600lm	55°	22	1006080	133,75	
2700K	3500lm	20°	22	1006039	133,75	
	3500lm	40°	22	1006042	133,75	
	3500lm	55°	22	1006045	133,75	
3000K	3550lm	20°	22	1006057	133,75	
	3550lm	40°	22	1006060	133,75	
	3550lm	55°	22	1006063	133,75	
4000K	3800lm	20°	22	1006075	133,75	
	3800lm	40°	22	1006078	133,75	
	3800lm	55°	22	1006081	133,75	
2700K	3400lm	20°	22	1006040	133,75	
	3400lm	40°	22	1006043	133,75	
	3400lm	55°	22	1006046	133,75	
3000K	3500lm	20°	22	1006058	133,75	
	3500lm	40°	22	1006061	133,75	
	3500lm	55°	22	1006064	133,75	
4000K	3750lm	20°	22	1006076	133,75	
	3750lm	40°	22	1006079	133,75	
	3750lm	55°	22	1006082	133,75	

ZUBEHÖR

Perfekte Treiberzuordnung



LED Treiber
200mA, 10W QC

LED Treiber
200mA, 10W,
PHASE QC

LED Treiber
200mA, 30W,
DALI QC

LED Treiber
250mA, 10W

LED Treiber
250mA, 10W,
PHASE

LED Treiber
250mA, 20W,
DALI

XS

XS

XS

S

S

S

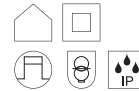
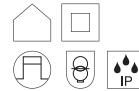
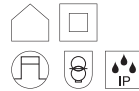
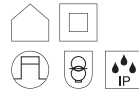

200mA

200mA

200mA

250mA

250mA

250/350/500/700mA

Material	Polycarbonat (PC)	Polycarbonat (PC)	Polycarbonat (PC)	Polycarbonat (PC)	Polycarbonat (PC)	Polycarbonat (PC)
Farbe	weiß	weiß	weiß	weiß	weiß	weiß
Spannung prim.	200-240V ~50/60Hz	200-240V ~50/60Hz	200-240V ~50/60Hz	220-240V ~50/60Hz	220-240V ~50/60Hz	220-240V ~50/60Hz
Spannung sek.	29-42V DC	30-42V DC	15-54V DC	26-40V	30-42V	6-60V
Ausgangsstrom	200mA	200mA	200mA	250mA	250mA	250mA
Anzahl Ausgänge sek.	1	1	1	1	1	1
Leistung von	5,8W	6W	3,8W	6,5W	7,5W	1,5W
Leistung bis	8,4W	8,4W	13,5W	10W	10W	15W
Umgebungstemp. min.	-	-	-	-20°C	-20°C	-20°C
Umgebungstemp. max.	-	-	-	45°C	50°C	50°C
Temperaturschutz	110°C	110°C	110°C	110°C	110°C	110°C
IP-Schutzart	IP 20	IP 20	IP 20	IP 20	IP 20	IP 20
Dimmbar	-	PHASE C	DALI	-	PHASE C	DALI
Länge	6,5 cm	8,5 cm	18 cm	6,5 cm	8,5 cm	15 cm
Breite	3,9 cm	4,1 cm	4,5 cm	3,9 cm	3,9 cm	5,2 cm
Höhe	3,5 cm	3 cm	3 cm	2 cm	2,2 cm	2,8 cm
Art. Nr.	1005610	1005609	1005611	1004058	1004055	1004067
EUR	24,61	33,71	90,95	24,61	38,52	77,04

Diffusoren

XS

S

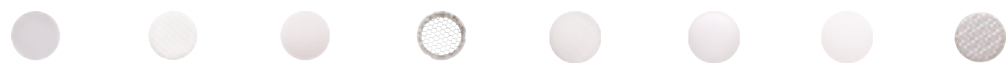

Diffusor
elliptisch

Diffusor
prismatisch

Diffusor
gefrostet

Diffusor
Wabe

Diffusor
elliptisch

Diffusor
prismatisch

Diffusor
gefrostet

Diffusor
Wabe

Art. Nr.	1005612	1005613	1005614	1005615	1004786	1004787	1004788	1004789
EUR	4,01	4,65	4,65	7,49	4,01	4,65	4,65	7,49

ZUBEHÖR



LED Treiber
500mA, 30W



LED Treiber
500mA, 30W,
PHASE



LED Treiber
500mA, 40W,
DALI

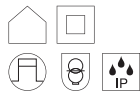
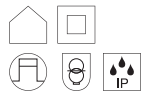
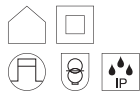

500/600/700mA

500mA

500/700/1050mA

Material	Polycarbonat (PC)	Polycarbonat (PC)	Polycarbonat (PC)
Farbe	weiß	weiß	weiß
Spannung prim.	220-240V ~50/60Hz	220-240V ~50/60Hz	220-240V ~50/60Hz
Spannung sek.	30-42V	25-42V	6-58V
Ausgangsstrom	500mA	500mA	500mA
Anzahl Ausgänge sek.	1	1	1
Leistung von	15W	12,5W	1,5W
Leistung bis	29,5W	21W	40,6W
Umgebungstemp. min.	-20°C	-25°C	-25°C
Umgebungstemp. max.	50°C	50°C	50°C
Temperaturschutz	110°C	110°C	110°C
IP-Schutzart	IP 20	IP 20	IP 20
Dimmbar	-	PHASE C	DALI
Länge	14,7 cm	11,5 cm	12,3 cm
Breite	4,3 cm	4,1 cm	7,9 cm
Höhe	3 cm	2,5 cm	2,4 cm
Art. Nr.	1004064	1004054	1004069
EUR	28,89	55,64	77,04



Diffusor
elliptisch

Diffusor
prismatisch

Diffusor
gefrostet

Diffusor
Wabe

Art. Nr.	1004790	1004791	1004792	1004793
EUR	4,01	5,19	5,19	11,24

ZUBEHÖR

Perfekte Treiberzuordnung



LED Treiber
1050mA, 40W



LED Treiber
700mA, 30W,
PHASE



LED Treiber
700mA, 40W, DALI



LED Treiber
1050mA, 40W



LED Treiber
1000mA, 40W,
PHASE



LED Treiber
1050mA, 50W,
DALI



500/600/700mA



700mA



700mA



800/900/1050mA



1000mA



1050mA

Material	Polycarbonat (PC)	Polycarbonat (PC)	Polycarbonat (PC)	Polycarbonat (PC)	Polycarbonat (PC)	Polycarbonat (PC)
Farbe	weiß	weiß	weiß	weiß	weiß	weiß
Spannung prim.	220-240V ~50/60Hz	220-240V ~50/60Hz	220-240V ~50/60Hz	220-240V ~50/60Hz	220-240V ~50/60Hz	220-240V ~50/60Hz
Spannung sek.	30-42V	30-42V	6-58V	30-42V	25-40V	6-58V
Ausgangsstrom	700mA	700mA	250/350/500/700mA	1050mA	1050mA	1050mA
Anzahl Ausgänge sek.	1	1	1	1	1	1
Leistung von	15W	21W	1,5W	24W	26,3W	4,2W
Leistung bis	29,5W	29,4W	40,6W	44W	42W	50W
Umgebungstemp. min.	-20°C	-20°C	-25°C	-20°C	-20°C	-25°C
Umgebungstemp. max.	50°C	50°C	50°C	50°C	50°C	50°C
Temperaturschutz	110°C	110°C	110°C	110°C	110°C	110°C
IP-Schutzart	IP 20	IP 20	IP 20	IP 20	IP 20	IP 20
Dimmbar	-	PHASE C	DALI	-	PHASE C	DALI
Länge	14,7 cm	11,5 cm	12,3 cm	9,7 cm	14,5 cm	12,3 cm
Breite	4,3 cm	4,4 cm	7,9 cm	4,3 cm	4 cm	7,9 cm
Höhe	3 cm	3 cm	2,4 cm	3 cm	3 cm	2,4 cm
Art. Nr.	1004062	1004065	1004070	1004059	1004066	1004071
EUR	28,89	55,64	77,04	28,89	58,85	77,04

Diffusoren



Diffusor
elliptisch



Diffusor
prismatisch



Diffusor
gefrostet



Diffusor
Wabe



Diffusor
elliptisch



Diffusor
prismatisch



Diffusor
gefrostet



Diffusor
Wabe

Art. Nr.	1004794	1004795	1004796	1004797	1004798	1004799	1004800	1004801
EUR	5,19	5,72	5,72	14,71	5,72	6,37	6,37	19,26

ZEIT FÜR VERÄNDERUNG. ZEIT FÜR EIN UPDATE.

Eine veraltete, oft noch mit konventionellen Leuchtmitteln ausgestattete Deckeneinbauleuchte soll einer energieeffizienten und kostensparenden Alternative weichen. Bei der Demontage finden Sie dabei häufig einen größeren Deckenausschnitt vor als benötigt.

Hier bietet SLV die passende Lösung: unsere neuen Reduzierringe.

Die Reduzierringe decken den größeren Deckenausschnitt komplett ab und geben gleichzeitig Ihrer neuen, kompakten Deckeneinbauleuchte perfekten Halt.

Sauber, zeitsparend, unkompliziert.

Und dabei perfekt abgestimmt auf das SLV NUMINOS® Down – und Spotlightsystem.



1. Die alte Leuchte hat einen größeren Durchmesser, als die Neue? Kein Problem!



2. Deinstallieren Sie die alte Deckeneinbauleuchte.



3. Setzen Sie einen der neuen Leuchte angepassten Reduzierring ein.



4. Durch den Reduzierring haben Sie den vergrößerten Deckenausschnitt gänzlich abgedeckt.



5. Nun können Sie den elektrischen Anschluss und die Installation der neuen Deckeneinbauleuchte abschließen.



6. Dank des Reduzierings ist der größere Deckenausschnitt nun nicht mehr sichtbar.

Reduzierring rund



	16 cm	16 cm	24 cm	24 cm	24 cm
Material	Stahl	Stahl	Stahl	Stahl	Stahl
Außen-Ø	16 cm	16 cm	24 cm	24 cm	24 cm
Höhe	5,3 cm	5,3 cm	5,3 cm	5,3 cm	5,3 cm
Innen-Ø	7 cm	9 cm	12 cm	15 cm	18 cm
Deckenausschnitt	8,5 - 13 cm	12 - 15 cm	14 - 18 cm	17 - 20 cm	20 - 22 cm
Materialdicke	3 cm	3 cm	3 cm	3 cm	3 cm
Art. Nr. schwarz	1006135	1006139	1006143	1006147	1006151
Art. Nr. weiß	1006136	1006140	1006144	1006148	1006152
EUR	16,05	13,91	17,12	16,05	14,98

Reduzierring eckig



	16 cm	16 cm	24 cm	24 cm	24 cm
Material	Stahl	Stahl	Stahl	Stahl	Stahl
Länge	16 cm	16 cm	24 cm	24 cm	24 cm
Breite	16 cm	16 cm	24 cm	24 cm	24 cm
Höhe	5,3 cm	5,3 cm	5,3 cm	5,3 cm	5,3 cm
Innen-Ø	7 cm	9 cm	12 cm	15 cm	18 cm
Deckenausschnitt	8,5 - 13 cm	12 - 15 cm	14 - 18 cm	17 - 20 cm	20 - 22 cm
Materialdicke	3 cm	3 cm	3 cm	3 cm	3 cm
Art. Nr. schwarz	1006137	1006141	1006145	1006149	1006153
Art. Nr. weiß	1006138	1006142	1006146	1006150	1006154
EUR	16,05	13,91	17,12	16,05	14,98

SLV NUMINOS® S



3Ph.

Produktangaben:

220-240V ~50/60Hz | 250mA

Systemleistung: 11W

Material: Aluminium / Polycarbonat (PC)

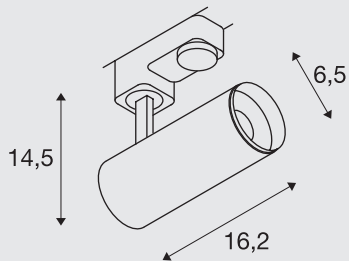

■ schwarz

Hinweis:

Zierring auch in Weiß erhältlich



Zierring S ■ weiß Art. Nr. 1006167 0,95 EUR

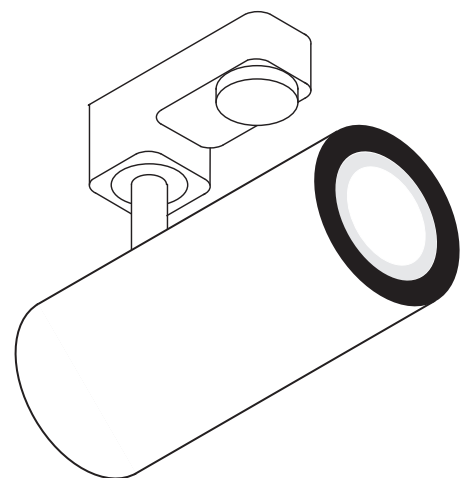

□ weiß



ART. NR.

EUR



	985lm	24°	16	1004074	111,28
2700K	985lm	36°	16	1004075	111,28
	980lm	60°	19	1004076	111,28
	1020lm	24°	13	1004082	111,28
3000K	1020lm	36°	13	1004083	111,28
	1020lm	60°	19	1004084	111,28
	1100lm	24°	16	1004090	111,28
4000K	1100lm	36°	16	1004091	111,28
	1100lm	60°	19	1004092	111,28



	985lm	24°	16	1004362	165,85
2700K	985lm	36°	16	1004363	165,85
	980lm	60°	19	1004364	165,85
	1020lm	24°	13	1004370	165,85
3000K	1020lm	36°	13	1004371	165,85
	1020lm	60°	19	1004372	165,85
	1100lm	24°	16	1004378	165,85
4000K	1100lm	36°	16	1004379	165,85
	1100lm	60°	19	1004380	165,85



	985lm	24°	16	1004078	111,28
2700K	985lm	36°	16	1004079	111,28
	980lm	60°	19	1004080	111,28
	1020lm	24°	13	1004086	111,28
3000K	1020lm	36°	13	1004087	111,28
	1020lm	60°	19	1004088	111,28
	1100lm	24°	16	1004094	111,28
4000K	1100lm	36°	16	1004095	111,28
	1100lm	60°	19	1004096	111,28



	985lm	24°	16	1004366	165,85
2700K	985lm	36°	16	1004367	165,85
	980lm	60°	19	1004368	165,85
	1020lm	24°	13	1004374	165,85
3000K	1020lm	36°	13	1004375	165,85
	1020lm	60°	19	1004376	165,85
	1100lm	24°	16	1004382	165,85
4000K	1100lm	36°	16	1004383	165,85
	1100lm	60°	19	1004384	165,85



SLV NUMINOS® M



3Ph.

Produktangaben:

220-240V ~50/60Hz | 500mA

Systemleistung: 20W

Material: Aluminium / Polycarbonat (PC)

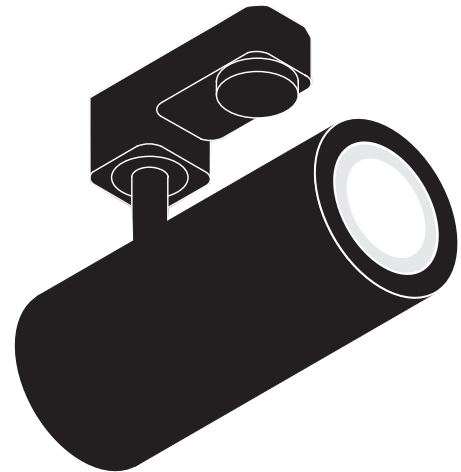
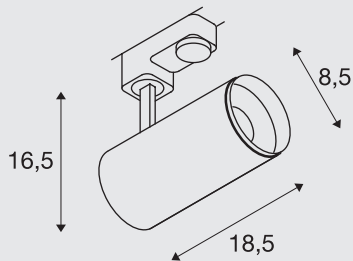

■ schwarz

Hinweis:

Zierring auch in Weiß erhältlich



Zierring M ■ weiß Art. Nr. 1006168 1,95 EUR

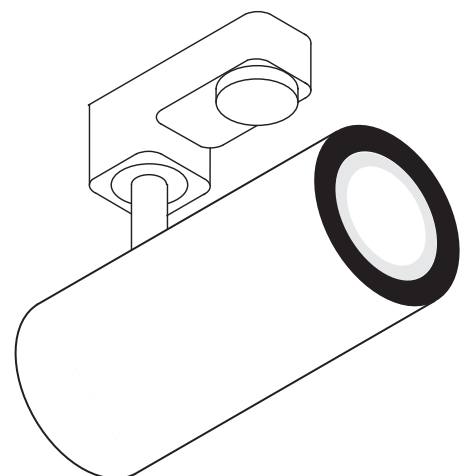

□ weiß



ART. NR.

EUR



	1925lm	24°	16	1004170	138,03
2700K	1935lm	36°	16	1004171	138,03
	1885lm	60°	22	1004172	138,03
	1955lm	24°	16	1004178	138,03
3000K	1970lm	36°	13	1004179	138,03
	1880lm	60°	22	1004180	138,03
	2125lm	24°	19	1004186	138,03
4000K	2120lm	36°	16	1004187	138,03
	2060lm	60°	25	1004188	138,03



	1925lm	24°	16	1004458	181,90
2700K	1935lm	36°	16	1004459	181,90
	1885lm	60°	22	1004460	181,90
	1955lm	24°	16	1004466	181,90
3000K	1970lm	36°	13	1004467	181,90
	1880lm	60°	22	1004468	181,90
	2125lm	24°	19	1004474	181,90
4000K	2120lm	36°	16	1004475	181,90
	2060lm	60°	25	1004476	181,90



	1925lm	24°	16	1004174	138,03
2700K	1935lm	36°	16	1004175	138,03
	1885lm	60°	22	1004176	138,03
	1955lm	24°	16	1004182	138,03
3000K	1970lm	36°	13	1004183	138,03
	1880lm	60°	22	1004184	138,03
	2125lm	24°	19	1004190	138,03
4000K	2120lm	36°	16	1004191	138,03
	2060lm	60°	25	1004192	138,03



	1925lm	24°	16	1004462	181,90
2700K	1935lm	36°	16	1004463	181,90
	1885lm	60°	22	1004464	181,90
	1955lm	24°	16	1004470	181,90
3000K	1970lm	36°	13	1004471	181,90
	1880lm	60°	22	1004472	181,90
	2125lm	24°	19	1004478	181,90
4000K	2120lm	36°	16	1004479	181,90
	2060lm	60°	25	1004480	181,90



SLV NUMINOS® L



3Ph.

Produktangaben:

220-240V ~50/60Hz | 700mA

Systemleistung: 28W

Material: Aluminium / Polycarbonat (PC)

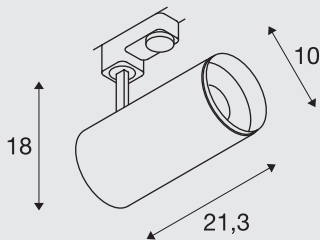

■ schwarz

Hinweis:

Zierring auch in Weiß erhältlich



Zierring L ■ weiß Art. Nr. 1006169 1,95 EUR

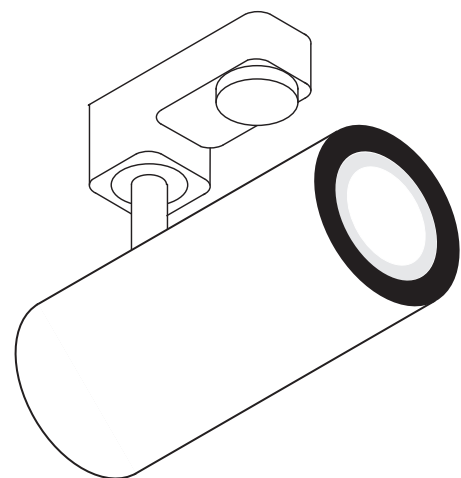

□ weiß



ART. NR.

EUR



	2440lm	24°	19	1004266	153,01
2700K	2400lm	36°	19	1004267	153,01
	2475lm	60°	22	1004268	153,01
3000K	2430lm	24°	13	1004274	153,01
	2340lm	36°	13	1004275	153,01
	2400lm	60°	22	1004276	153,01
4000K	2675lm	24°	19	1004282	153,01
	2620lm	36°	19	1004283	153,01
	2715lm	60°	22	1004284	153,01



	2440lm	24°	19	1004554	215,07
2700K	2400lm	36°	19	1004555	215,07
	2475lm	60°	22	1004556	215,07
3000K	2430lm	24°	13	1004562	215,07
	2340lm	36°	13	1004563	215,07
	2400lm	60°	22	1004564	215,07
4000K	2675lm	24°	19	1004570	215,07
	2620lm	36°	19	1004571	215,07
	2715lm	60°	22	1004572	215,07



	2440lm	24°	19	1004270	153,01
2700K	2400lm	36°	19	1004271	153,01
	2475lm	60°	22	1004272	153,01
3000K	2430lm	24°	13	1004278	153,01
	2340lm	36°	13	1004279	153,01
	2400lm	60°	22	1004280	153,01
4000K	2675lm	24°	19	1004286	153,01
	2620lm	36°	19	1004287	153,01
	2715lm	60°	22	1004288	153,01



	2440lm	24°	19	1004558	215,07
2700K	2400lm	36°	19	1004559	215,07
	2475lm	60°	22	1004560	215,07
3000K	2430lm	24°	13	1004566	215,07
	2340lm	36°	13	1004567	215,07
	2400lm	60°	22	1004568	215,07
4000K	2675lm	24°	19	1004574	215,07
	2620lm	36°	19	1004575	215,07
	2715lm	60°	22	1004576	215,07



SLV NUMINOS® XL



3Ph.

Produktangaben:

220-240V ~50/60Hz | 900mA

Systemleistung: 36W

Material: Aluminium / Polycarbonat (PC)

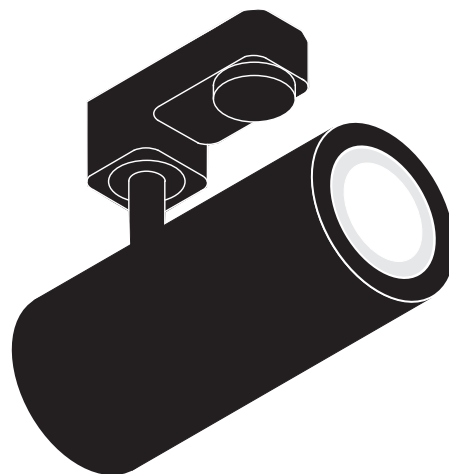
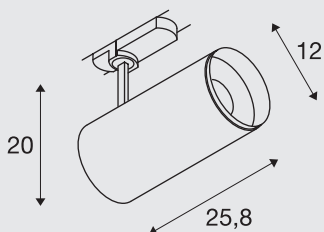

■ schwarz

Hinweis:

Zierring auch in Weiß erhältlich



Zierring XL

■ weiß

Art. Nr. 1006170

2,95 EUR

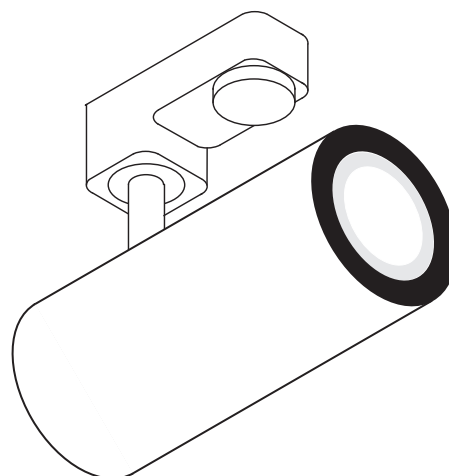

□ weiß



ART. NR.

EUR



	3290lm	24°	19	1005723	181,90
2700K	3250lm	36°	19	1005724	181,90
	2980lm	60°	25	1005725	181,90
	3530lm	24°	19	1005729	181,90
3000K	3490lm	36°	19	1005730	181,90
	3210lm	60°	25	1005731	181,90
	3800lm	24°	19	1005735	181,90
4000K	3760lm	36°	19	1005736	181,90
	3460lm	60°	25	1005737	181,90



	3290lm	24°	19	1005795	240,75
2700K	3250lm	36°	19	1005796	240,75
	2980lm	60°	25	1005797	240,75
	3530lm	24°	19	1005801	240,75
3000K	3490lm	36°	19	1005802	240,75
	3210lm	60°	25	1005803	240,75
	3800lm	24°	19	1005807	240,75
4000K	3760lm	36°	19	1005808	240,75
	3460lm	60°	25	1005809	240,75



	3290lm	24°	19	1005726	181,90
2700K	3250lm	36°	19	1005727	181,90
	2980lm	60°	25	1005728	181,90
	3530lm	24°	19	1005732	181,90
3000K	3490lm	36°	19	1005733	181,90
	3210lm	60°	25	1005734	181,90
	3800lm	24°	19	1005738	181,90
4000K	3760lm	36°	19	1005739	181,90
	3460lm	60°	25	1005740	181,90



	3290lm	24°	19	1005798	240,75
2700K	3250lm	36°	19	1005799	240,75
	2980lm	60°	25	1005800	240,75
	3530lm	24°	19	1005804	240,75
3000K	3490lm	36°	19	1005805	240,75
	3210lm	60°	25	1005806	240,75
	3800lm	24°	19	1005810	240,75
4000K	3760lm	36°	19	1005811	240,75
	3460lm	60°	25	1005812	240,75



SLV NUMINOS® ZOOM M 3Ph.



Produktangaben:

220-240V ~50/60Hz | 500mA

Systemleistung: 20W

Material: Aluminium / Polycarbonat (PC)

- Halbstreuwinkel einstellbar von 15°-60°.

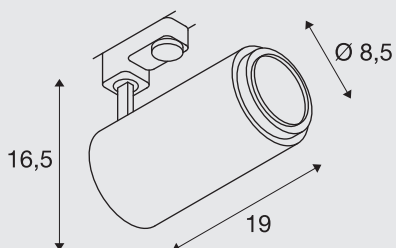
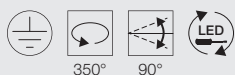

Hinweis:

Zierring auch in Weiß erhältlich

Zierring M weiß Art. Nr. 1006168 1,95 EUR

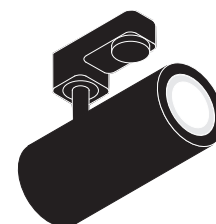

schwarz

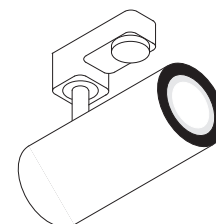

weiß



					ART. NR.	EUR	
	2700K	680-1650lm	15°-60°	25	1006108	169,06	
	3000K	750-1800lm	15°-60°	25	1006110	169,06	
	4000K	780-1900lm	15°-60°	25	1006112	169,06	
	2700K	680-1650lm	15°-60°	25	1006114	214,00	
	3000K	750-1800lm	15°-60°	25	1006116	214,00	
	4000K	780-1900lm	15°-60°	25	1006118	214,00	
	2700K	680-1650lm	15°-60°	25	1006109	169,06	
	3000K	750-1800lm	15°-60°	25	1006111	169,06	
	4000K	780-1900lm	15°-60°	25	1006113	169,06	
	2700K	680-1650lm	15°-60°	25	1006115	214,00	
	3000K	750-1800lm	15°-60°	25	1006117	214,00	
	4000K	780-1900lm	15°-60°	25	1006119	214,00	



SLV NUMINOS® S



CW

Produktangaben:

220-240V ~50/60Hz | 250mA

Systemleistung: 11W

Material: Aluminium / Polycarbonat (PC)

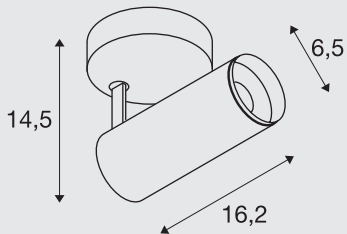

Hinweis:

Zierring auch in Weiß erhältlich

Zierring S weiß Art. Nr. 1006167 0,95 EUR

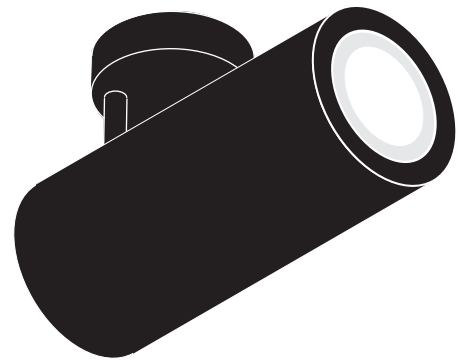

schwarz

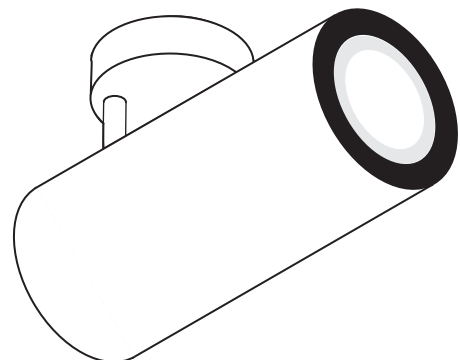

weiß



ART. NR.

EUR



2700K	985lm	24°	16	1004098	111,28
	985lm	36°	16	1004099	111,28
	980lm	60°	19	1004100	111,28
3000K	1020lm	24°	13	1004106	111,28
	1020lm	36°	13	1004107	111,28
	1020lm	60°	19	1004108	111,28
4000K	1100lm	24°	16	1004114	111,28
	1100lm	36°	16	1004115	111,28
	1100lm	60°	19	1004116	111,28



2700K	985lm	24°	16	1004386	165,85
	985lm	36°	16	1004387	165,85
	980lm	60°	19	1004388	165,85
3000K	1020lm	24°	13	1004394	165,85
	1020lm	36°	13	1004395	165,85
	1020lm	60°	19	1004396	165,85
4000K	1100lm	24°	16	1004402	165,85
	1100lm	36°	16	1004403	165,85
	1100lm	60°	19	1004404	165,85



2700K	985lm	24°	16	1004102	111,28
	985lm	36°	16	1004103	111,28
	980lm	60°	19	1004104	111,28
3000K	1020lm	24°	13	1004110	111,28
	1020lm	36°	13	1004111	111,28
	1020lm	60°	19	1004112	111,28
4000K	1100lm	24°	16	1004118	111,28
	1100lm	36°	16	1004119	111,28
	1100lm	60°	19	1004120	111,28



2700K	985lm	24°	16	1004390	165,85
	985lm	36°	16	1004391	165,85
	980lm	60°	19	1004392	165,85
3000K	1020lm	24°	13	1004398	165,85
	1020lm	36°	13	1004399	165,85
	1020lm	60°	19	1004400	165,85
4000K	1100lm	24°	16	1004406	165,85
	1100lm	36°	16	1004407	165,85
	1100lm	60°	19	1004408	165,85



TECHNISCHE DATEN

SLV NUMINOS® M



CL

Produktangaben:

220-240V ~50/60Hz | 500mA

Systemleistung: 20W

Material: Aluminium / Polycarbonat (PC)



L80B50

350°

90°

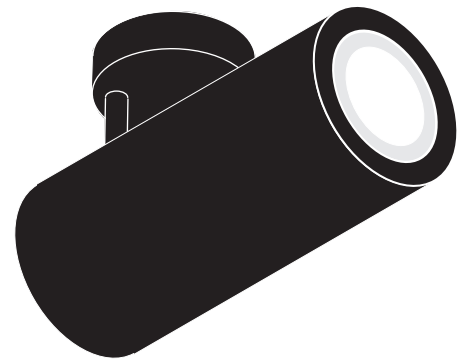
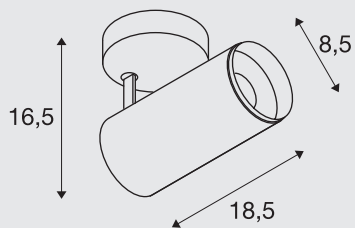

■ schwarz

Hinweis:

Zierring auch in Weiß erhältlich



Zierring M ■ weiß Art. Nr. 1006168 1,95 EUR

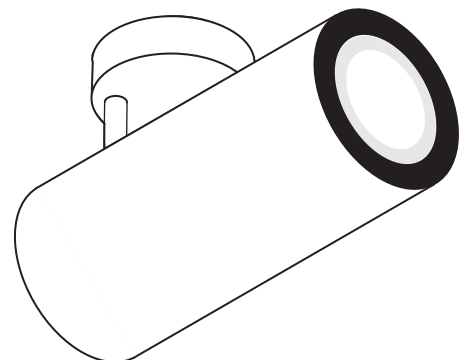

□ weiß



ART. NR.

EUR



	1925lm	24°	16	1004194	138,03
2700K	1935lm	36°	16	1004195	138,03
	1885lm	60°	22	1004196	138,03
	1955lm	24°	16	1004202	138,03
3000K	1970lm	36°	13	1004203	138,03
	1880lm	60°	22	1004204	138,03
	2125lm	24°	19	1004210	138,03
4000K	2120lm	36°	16	1004211	138,03
	2060lm	60°	25	1004212	138,03



	1925lm	24°	16	1004482	181,90
2700K	1935lm	36°	16	1004483	181,90
	1885lm	60°	22	1004484	181,90
	1955lm	24°	16	1004490	181,90
3000K	1970lm	36°	13	1004491	181,90
	1880lm	60°	22	1004492	181,90
	2125lm	24°	19	1004498	181,90
4000K	2120lm	36°	16	1004499	181,90
	2060lm	60°	25	1004500	181,90



	1925lm	24°	16	1004198	138,03
2700K	1935lm	36°	16	1004199	138,03
	1885lm	60°	22	1004200	138,03
	1955lm	24°	16	1004206	138,03
3000K	1970lm	36°	13	1004207	138,03
	1880lm	60°	22	1004208	138,03
	2125lm	24°	19	1004214	138,03
4000K	2120lm	36°	16	1004215	138,03
	2060lm	60°	25	1004216	138,03



	1925lm	24°	16	1004486	181,90
2700K	1935lm	36°	16	1004487	181,90
	1885lm	60°	22	1004488	181,90
	1955lm	24°	16	1004494	181,90
3000K	1970lm	36°	13	1004495	181,90
	1880lm	60°	22	1004496	181,90
	2125lm	24°	19	1004502	181,90
4000K	2120lm	36°	16	1004503	181,90
	2060lm	60°	25	1004504	181,90



SLV NUMINOS® L



CL

Produktangaben:

220-240V ~50/60Hz | 700mA

Systemleistung: 28W

Material: Aluminium / Polycarbonat (PC)

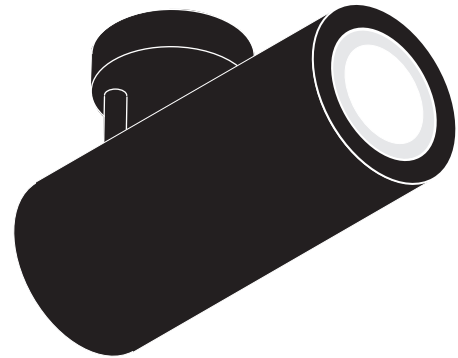
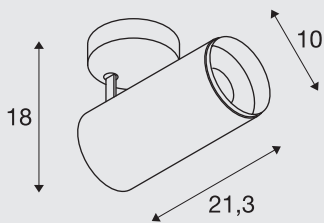

■ schwarz

Hinweis:

Zierring auch in Weiß erhältlich



Zierring L ■ weiß Art. Nr. 1006169 1,95 EUR

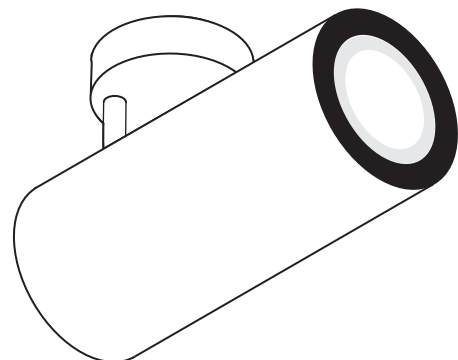

□ weiß



ART. NR.

EUR



	2440lm	24°	19	1004290	153,01
2700K	2400lm	36°	19	1004291	153,01
	2475lm	60°	22	1004292	153,01
	2430lm	24°	13	1004298	153,01
3000K	2340lm	36°	13	1004299	153,01
	2400lm	60°	22	1004300	153,01
	2675lm	24°	19	1004306	153,01
4000K	2620lm	36°	19	1004307	153,01
	2715lm	60°	22	1004308	153,01



	2440lm	24°	19	1004578	215,07
2700K	2400lm	36°	19	1004579	215,07
	2475lm	60°	22	1004580	215,07
	2430lm	24°	13	1004586	215,07
3000K	2340lm	36°	13	1004587	215,07
	2400lm	60°	22	1004588	215,07
	2675lm	24°	19	1004594	215,07
4000K	2620lm	36°	19	1004595	215,07
	2715lm	60°	22	1004596	215,07



	2440lm	24°	19	1004294	153,01
2700K	2400lm	36°	19	1004295	153,01
	2475lm	60°	22	1004296	153,01
	2430lm	24°	13	1004302	153,01
3000K	2340lm	36°	13	1004303	153,01
	2400lm	60°	22	1004304	153,01
	2675lm	24°	19	1004310	153,01
4000K	2620lm	36°	19	1004311	153,01
	2715lm	60°	22	1004312	153,01



	2440lm	24°	19	1004582	215,07
2700K	2400lm	36°	19	1004583	215,07
	2475lm	60°	22	1004584	215,07
	2430lm	24°	13	1004590	215,07
3000K	2340lm	36°	13	1004591	215,07
	2400lm	60°	22	1004592	215,07
	2675lm	24°	19	1004598	215,07
4000K	2620lm	36°	19	1004599	215,07
	2715lm	60°	22	1004600	215,07



SLV NUMINOS® XL



CL

Produktangaben:

220-240V ~50/60Hz | 900mA

Systemleistung: 36W

Material: Aluminium / Polycarbonat (PC)

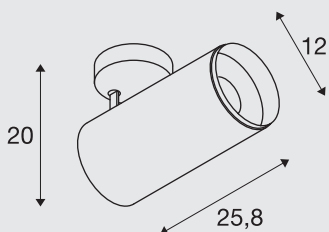

Hinweis:

Zierring auch in Weiß erhältlich

Zierring XL

■ weiß

Art. Nr. 1006170

2,95 EUR

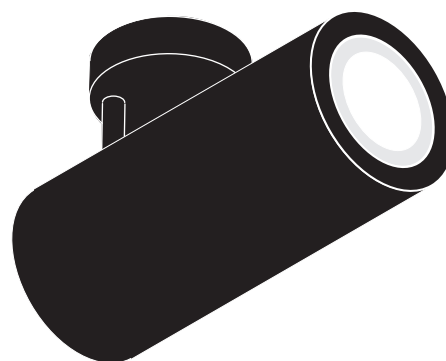

■ schwarz

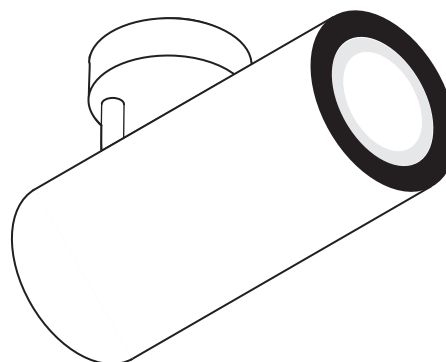

□ weiß



ART. NR.

EUR



	3290lm	24°	19	1006083	176,55
2700K	3250lm	36°	19	1006084	176,55
	2980lm	60°	25	1006085	176,55
	3530lm	24°	19	1006089	176,55
3000K	3490lm	36°	19	1006090	176,55
	3210lm	60°	25	1006091	176,55
4000K	3800lm	24°	19	1006095	176,55
	3760lm	36°	19	1006096	176,55
	3460lm	60°	25	1006097	176,55



	3290lm	24°	19	1005741	235,40
2700K	3250lm	36°	19	1005742	235,40
	2980lm	60°	25	1005743	235,40
	3530lm	24°	19	1005747	235,40
3000K	3490lm	36°	19	1005748	235,40
	3210lm	60°	25	1005749	235,40
4000K	3800lm	24°	19	1005753	235,40
	3760lm	36°	19	1005754	235,40
	3460lm	60°	25	1005755	235,40



	3290lm	24°	19	1006086	176,55
2700K	3250lm	36°	19	1006087	176,55
	2980lm	60°	25	1006088	176,55
	3530lm	24°	19	1006092	176,55
3000K	3490lm	36°	19	1006093	176,55
	3210lm	60°	25	1006094	176,55
4000K	3800lm	24°	19	1006098	176,55
	3760lm	36°	19	1006099	176,55
	3460lm	60°	25	1006100	176,55



	3290lm	24°	19	1005744	235,40
2700K	3250lm	36°	19	1005745	235,40
	2980lm	60°	25	1005746	235,40
	3530lm	24°	19	1005750	235,40
3000K	3490lm	36°	19	1005751	235,40
	3210lm	60°	25	1005752	235,40
4000K	3800lm	24°	19	1005756	235,40
	3760lm	36°	19	1005757	235,40
	3460lm	60°	25	1005758	235,40



TECHNISCHE DATEN

SLV NUMINOS® S



CL

Produktangaben:

220-240V ~50/60Hz | 250mA

Systemleistung: 11W

Material: Aluminium / Polycarbonat (PC)

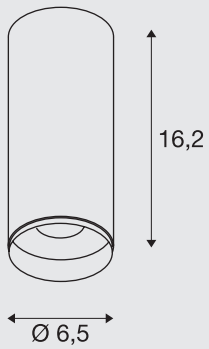

Hinweis:

Zierring auch in Weiß erhältlich

Zierring S weiß Art. Nr. 1006167 0,95 EUR



schwarz

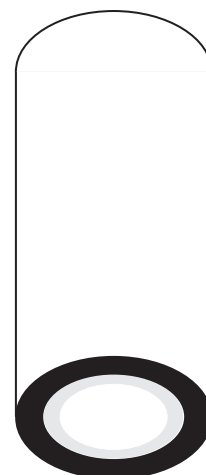

weiß

**ART. NR.****EUR**

	985lm	24°	16	1004122	97,37
2700K	985lm	36°	16	1004123	97,37
	980lm	60°	19	1004124	97,37
	1020lm	24°	13	1004130	97,37
3000K	1020lm	36°	13	1004131	97,37
	1020lm	60°	19	1004132	97,37
	1100lm	24°	16	1004138	97,37
4000K	1100lm	36°	16	1004139	97,37
	1100lm	60°	19	1004140	97,37



	985lm	24°	16	1004410	143,38
2700K	985lm	36°	16	1004411	143,38
	980lm	60°	19	1004412	143,38
	1020lm	24°	13	1004418	143,38
3000K	1020lm	36°	13	1004419	143,38
	1020lm	60°	19	1004420	143,38
	1100lm	24°	16	1004426	143,38
4000K	1100lm	36°	16	1004427	143,38
	1100lm	60°	19	1004428	143,38



	985lm	24°	16	1004126	97,37
2700K	985lm	36°	16	1004127	97,37
	980lm	60°	19	1004128	97,37
	1020lm	24°	13	1004134	97,37
3000K	1020lm	36°	13	1004135	97,37
	1020lm	60°	19	1004136	97,37
	1100lm	24°	16	1004142	97,37
4000K	1100lm	36°	16	1004143	97,37
	1100lm	60°	19	1004144	97,37



	985lm	24°	16	1004414	143,38
2700K	985lm	36°	16	1004415	143,38
	980lm	60°	19	1004416	143,38
	1020lm	24°	13	1004422	143,38
3000K	1020lm	36°	13	1004423	143,38
	1020lm	60°	19	1004424	143,38
	1100lm	24°	16	1004430	143,38
4000K	1100lm	36°	16	1004431	143,38
	1100lm	60°	19	1004432	143,38



SLV NUMINOS® M



CL

Produktangaben:

220-240V ~50/60Hz | 500mA

Systemleistung: 20W

Material: Aluminium / Polycarbonat (PC)



L80B50

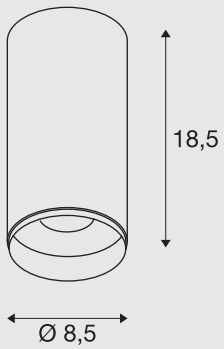

Hinweis:

Zierring auch in Weiß erhältlich

Zierring M weiß Art. Nr. 1006168 1,95 EUR



schwarz

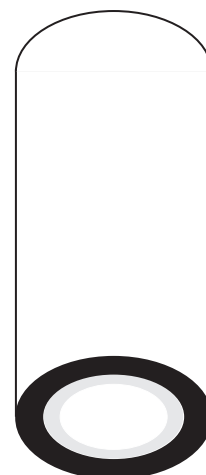

weiß



ART. NR.

EUR



	1925lm	24°	16	1004218	120,91
2700K	1935lm	36°	16	1004219	120,91
	1885lm	60°	22	1004220	120,91
	1955lm	24°	16	1004226	120,91
3000K	1970lm	36°	13	1004227	120,91
	1880lm	60°	22	1004228	120,91
	2125lm	24°	19	1004234	120,91
4000K	2120lm	36°	16	1004235	120,91
	2060lm	60°	25	1004236	120,91



	1925lm	24°	16	1004506	154,08
2700K	1935lm	36°	16	1004507	154,08
	1885lm	60°	22	1004508	154,08
	1955lm	24°	16	1004514	154,08
3000K	1970lm	36°	13	1004515	154,08
	1880lm	60°	22	1004516	154,08
	2125lm	24°	19	1004522	154,08
4000K	2120lm	36°	16	1004523	154,08
	2060lm	60°	25	1004524	154,08



	1925lm	24°	16	1004222	120,91
2700K	1935lm	36°	16	1004223	120,91
	1885lm	60°	22	1004224	120,91
	1955lm	24°	16	1004230	120,91
3000K	1970lm	36°	13	1004231	120,91
	1880lm	60°	22	1004232	120,91
	2125lm	24°	19	1004238	120,91
4000K	2120lm	36°	16	1004239	120,91
	2060lm	60°	25	1004240	120,91



	1925lm	24°	16	1004510	154,08
2700K	1935lm	36°	16	1004511	154,08
	1885lm	60°	22	1004512	154,08
	1955lm	24°	16	1004518	154,08
3000K	1970lm	36°	13	1004519	154,08
	1880lm	60°	22	1004520	154,08
	2125lm	24°	19	1004526	154,08
4000K	2120lm	36°	16	1004527	154,08
	2060lm	60°	25	1004528	154,08



SLV NUMINOS® L



CL

Produktangaben:

220-240V ~50/60Hz | 700mA

Systemleistung: 28W

Material: Aluminium / Polycarbonat (PC)

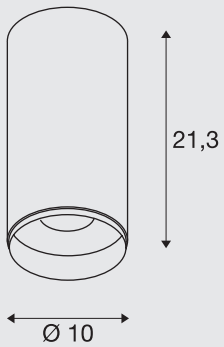

Hinweis:

Zierring auch in Weiß erhältlich

Zierring L weiß Art. Nr. 1006169 1,95 EUR



schwarz

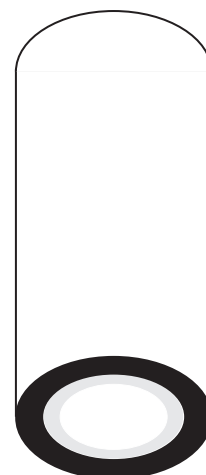

weiß



ART. NR.

EUR



		2440lm	24°	19	1004314	140,17
2700K		2400lm	36°	19	1004315	140,17
		2475lm	60°	22	1004316	140,17
		2430lm	24°	13	1004322	140,17
3000K		2340lm	36°	13	1004323	140,17
		2400lm	60°	22	1004324	140,17
		2675lm	24°	19	1004330	140,17
4000K		2620lm	36°	19	1004331	140,17
		2715lm	60°	22	1004332	140,17



		2440lm	24°	19	1004602	189,39
2700K		2400lm	36°	19	1004603	189,39
		2475lm	60°	22	1004604	189,39
		2430lm	24°	13	1004610	189,39
3000K		2340lm	36°	13	1004611	189,39
		2400lm	60°	22	1004612	189,39
		2675lm	24°	19	1004618	189,39
4000K		2620lm	36°	19	1004619	189,39
		2715lm	60°	22	1004620	189,39



		2440lm	24°	19	1004318	140,17
2700K		2400lm	36°	19	1004319	140,17
		2475lm	60°	22	1004320	140,17
		2430lm	24°	13	1004326	140,17
3000K		2340lm	36°	13	1004327	140,17
		2400lm	60°	22	1004328	140,17
		2675lm	24°	19	1004334	140,17
4000K		2620lm	36°	19	1004335	140,17
		2715lm	60°	22	1004336	140,17



		2440lm	24°	19	1004606	189,39
2700K		2400lm	36°	19	1004607	189,39
		2475lm	60°	22	1004608	189,39
		2430lm	24°	13	1004614	189,39
3000K		2340lm	36°	13	1004615	189,39
		2400lm	60°	22	1004616	189,39
		2675lm	24°	19	1004622	189,39
4000K		2620lm	36°	19	1004623	189,39
		2715lm	60°	22	1004624	189,39



SLV NUMINOS® XL



CL

Produktangaben:

220-240V ~50/60Hz | 900mA

Systemleistung: 36W

Material: Aluminium / Polycarbonat (PC)

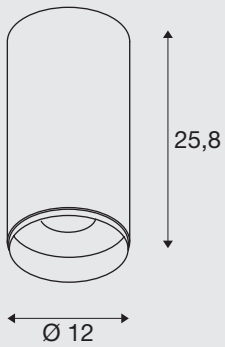

Hinweis:

Zierring auch in Weiß erhältlich

Zierring XL weiß Art. Nr. 1006170 2,95 EUR



schwarz

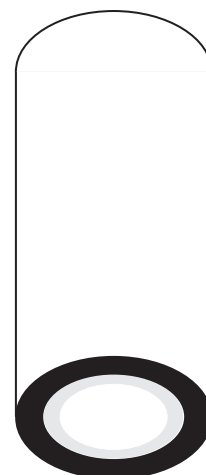

weiß



ART. NR.

EUR



		3290lm	24°	19	1005687	176,55
2700K		3250lm	36°	19	1005688	176,55
		2980lm	60°	25	1005689	176,55
		3530lm	24°	19	1005693	176,55
3000K		3490lm	36°	19	1005694	176,55
		3210lm	60°	25	1005695	176,55
		3800lm	24°	19	1005699	176,55
4000K		3760lm	36°	19	1005700	176,55
		3460lm	60°	25	1005701	176,55



		3290lm	24°	19	1005759	235,40
2700K		3250lm	36°	19	1005760	235,40
		2980lm	60°	25	1005761	235,40
		3530lm	24°	19	1005765	235,40
3000K		3490lm	36°	19	1005766	235,40
		3210lm	60°	25	1005767	235,40
		3800lm	24°	19	1005771	235,40
4000K		3760lm	36°	19	1005772	235,40
		3460lm	60°	25	1005773	235,40



		3290lm	24°	19	1005690	176,55
2700K		3250lm	36°	19	1005691	176,55
		2980lm	60°	25	1005692	176,55
		3530lm	24°	19	1005696	176,55
3000K		3490lm	36°	19	1005697	176,55
		3210lm	60°	25	1005698	176,55
		3800lm	24°	19	1005702	176,55
4000K		3760lm	36°	19	1005703	176,55
		3460lm	60°	25	1005704	176,55



		3290lm	24°	19	1005762	235,40
2700K		3250lm	36°	19	1005763	235,40
		2980lm	60°	25	1005764	235,40
		3530lm	24°	19	1005768	235,40
3000K		3490lm	36°	19	1005769	235,40
		3210lm	60°	25	1005770	235,40
		3800lm	24°	19	1005774	235,40
4000K		3760lm	36°	19	1005775	235,40
		3460lm	60°	25	1005776	235,40



SLV NUMINOS® S



PD

Produktangaben:

220-240V ~50/60Hz | 250mA

Systemleistung: 11W

Material: Aluminium / Polycarbonat (PC)

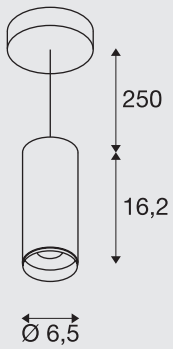
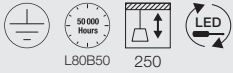

Hinweis:

Zierring auch in Weiß erhältlich

Zierring S weiß Art. Nr. 1006167 0,95 EUR



schwarz

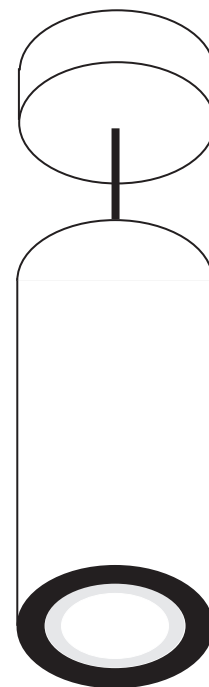

weiß



ART. NR.

EUR



	985lm	24°	16	1004146	132,68
2700K	985lm	36°	16	1004147	132,68
	980lm	60°	19	1004148	132,68
	1020lm	24°	13	1004154	132,68
3000K	1020lm	36°	13	1004155	132,68
	1020lm	60°	19	1004156	132,68
	1100lm	24°	16	1004162	132,68
4000K	1100lm	36°	16	1004163	132,68
	1100lm	60°	19	1004164	132,68



	985lm	24°	16	1004434	188,32
2700K	985lm	36°	16	1004435	188,32
	980lm	60°	19	1004436	188,32
	1020lm	24°	13	1004442	188,32
3000K	1020lm	36°	13	1004443	188,32
	1020lm	60°	19	1004444	188,32
	1100lm	24°	16	1004450	188,32
4000K	1100lm	36°	16	1004451	188,32
	1100lm	60°	19	1004452	188,32



	985lm	24°	16	1004150	132,68
2700K	985lm	36°	16	1004151	132,68
	980lm	60°	19	1004152	132,68
	1020lm	24°	13	1004158	132,68
3000K	1020lm	36°	13	1004159	132,68
	1020lm	60°	19	1004160	132,68
	1100lm	24°	16	1004166	132,68
4000K	1100lm	36°	16	1004167	132,68
	1100lm	60°	19	1004168	132,68



	985lm	24°	16	1004438	188,32
2700K	985lm	36°	16	1004439	188,32
	980lm	60°	19	1004440	188,32
	1020lm	24°	13	1004446	188,32
3000K	1020lm	36°	13	1004447	188,32
	1020lm	60°	19	1004448	188,32
	1100lm	24°	16	1004454	188,32
4000K	1100lm	36°	16	1004455	188,32
	1100lm	60°	19	1004456	188,32



SLV NUMINOS® M



PD

Produktangaben:

220-240V ~50/60Hz | 500mA

Systemleistung: 20W

Material: Aluminium / Polycarbonat (PC)

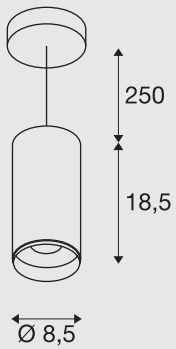
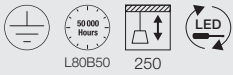

Hinweis:

Zierring auch in Weiß erhältlich

Zierring M weiß Art. Nr. 1006168 1,95 EUR



schwarz

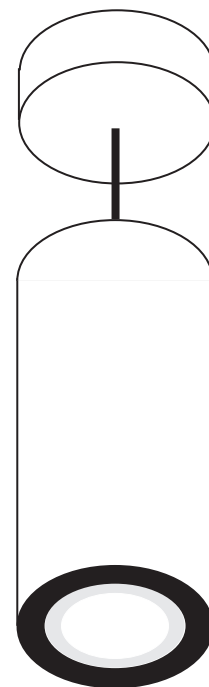

weiß



ART. NR.

EUR



	1925lm	24°	16	1004242	156,22
2700K	1935lm	36°	16	1004243	156,22
	1885lm	60°	22	1004244	156,22
	1955lm	24°	16	1004250	156,22
3000K	1970lm	36°	13	1004251	156,22
	1880lm	60°	22	1004252	156,22
	2125lm	24°	19	1004258	156,22
4000K	2120lm	36°	16	1004259	156,22
	2060lm	60°	25	1004260	156,22



	1925lm	24°	16	1004530	199,02
2700K	1935lm	36°	16	1004531	199,02
	1885lm	60°	22	1004532	199,02
	1955lm	24°	16	1004538	199,02
3000K	1970lm	36°	13	1004539	199,02
	1880lm	60°	22	1004540	199,02
	2125lm	24°	19	1004546	199,02
4000K	2120lm	36°	16	1004547	199,02
	2060lm	60°	25	1004548	199,02



	1925lm	24°	16	1004246	156,22
2700K	1935lm	36°	16	1004247	156,22
	1885lm	60°	22	1004248	156,22
	1955lm	24°	16	1004254	156,22
3000K	1970lm	36°	13	1004255	156,22
	1880lm	60°	22	1004256	156,22
	2125lm	24°	19	1004262	156,22
4000K	2120lm	36°	16	1004263	156,22
	2060lm	60°	25	1004264	156,22



	1925lm	24°	16	1004534	199,02
2700K	1935lm	36°	16	1004535	199,02
	1885lm	60°	22	1004536	199,02
	1955lm	24°	16	1004542	199,02
3000K	1970lm	36°	13	1004543	199,02
	1880lm	60°	22	1004544	199,02
	2125lm	24°	19	1004550	199,02
4000K	2120lm	36°	16	1004551	199,02
	2060lm	60°	25	1004552	199,02



SLV NUMINOS® L



PD

Produktangaben:

220-240V ~50/60Hz| 700mA

Systemleistung: 28W

Material: Aluminium / Polycarbonat (PC)

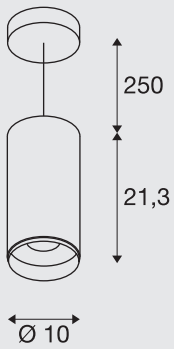

Hinweis:

Zierring auch in Weiß erhältlich

Zierring L weiß Art. Nr. 1006169 1,95 EUR



schwarz

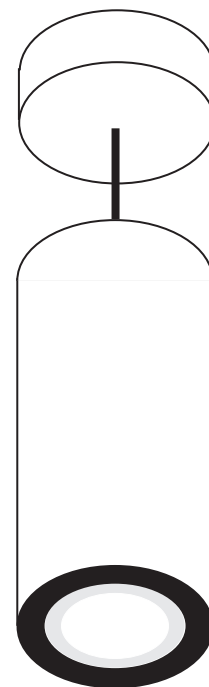

weiß



ART. NR.

EUR



		2440lm	24°	19	1004338	175,48
2700K		2400lm	36°	19	1004339	175,48
		2475lm	60°	22	1004340	175,48
		2430lm	24°	13	1004346	175,48
3000K		2340lm	36°	13	1004347	175,48
		2400lm	60°	22	1004348	175,48
		2675lm	24°	19	1004354	175,48
4000K		2620lm	36°	19	1004355	175,48
		2715lm	60°	22	1004356	175,48



		2440lm	24°	19	1004626	228,98
2700K		2400lm	36°	19	1004627	228,98
		2475lm	60°	22	1004628	228,98
		2430lm	24°	13	1004634	228,98
3000K		2340lm	36°	13	1004635	228,98
		2400lm	60°	22	1004636	228,98
		2675lm	24°	19	1004642	228,98
4000K		2620lm	36°	19	1004643	228,98
		2715lm	60°	22	1004644	228,98



		2440lm	24°	19	1004342	175,48
2700K		2400lm	36°	19	1004343	175,48
		2475lm	60°	22	1004344	175,48
		2430lm	24°	13	1004350	175,48
3000K		2340lm	36°	13	1004351	175,48
		2400lm	60°	22	1004352	175,48
		2675lm	24°	19	1004358	175,48
4000K		2620lm	36°	19	1004359	175,48
		2715lm	60°	22	1004360	175,48



		2440lm	24°	19	1004630	228,98
2700K		2400lm	36°	19	1004631	228,98
		2475lm	60°	22	1004632	228,98
		2430lm	24°	13	1004638	228,98
3000K		2340lm	36°	13	1004639	228,98
		2400lm	60°	22	1004640	228,98
		2675lm	24°	19	1004646	228,98
4000K		2620lm	36°	19	1004647	228,98
		2715lm	60°	22	1004648	228,98



SLV NUMINOS® XL



PD

Produktangaben:

220-240V ~50/60Hz | 900mA

Systemleistung: 36W

Material: Aluminium / Polycarbonat (PC)

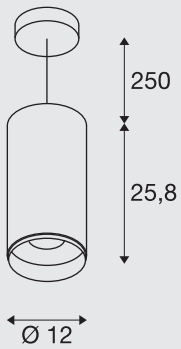
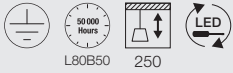

Hinweis:

Zierring auch in Weiß erhältlich

Zierring XL weiß Art. Nr. 1006170 2,95 EUR



schwarz

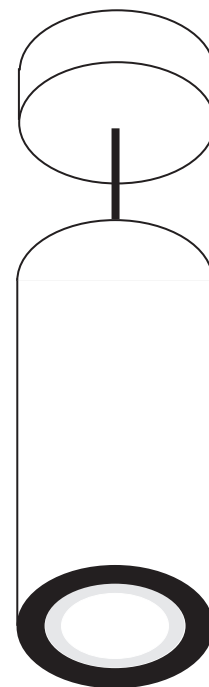

weiß



ART. NR.

EUR



		3290lm	24°	19	1005705	199,02
	2700K	3250lm	36°	19	1005706	199,02
		2980lm	60°	25	1005707	199,02
		3530lm	24°	19	1005711	199,02
	3000K	3490lm	36°	19	1005712	199,02
		3210lm	60°	25	1005713	199,02
		3800lm	24°	19	1005717	199,02
	4000K	3760lm	36°	19	1005718	199,02
		3460lm	60°	25	1005719	199,02



		3290lm	24°	19	1005777	252,52
	2700K	3250lm	36°	19	1005778	252,52
		2980lm	60°	25	1005779	252,52
		3530lm	24°	19	1005783	252,52
	3000K	3490lm	36°	19	1005784	252,52
		3210lm	60°	25	1005785	252,52
		3800lm	24°	19	1005789	252,52
	4000K	3760lm	36°	19	1005790	252,52
		3460lm	60°	25	1005791	252,52



		3290lm	24°	19	1005708	199,02
	2700K	3250lm	36°	19	1005709	199,02
		2980lm	60°	25	1005710	199,02
		3530lm	24°	19	1005714	199,02
	3000K	3490lm	36°	19	1005715	199,02
		3210lm	60°	25	1005716	199,02
		3800lm	24°	19	1005720	199,02
	4000K	3760lm	36°	19	1005721	199,02
		3460lm	60°	25	1005722	199,02



		3290lm	24°	19	1005780	252,52
	2700K	3250lm	36°	19	1005781	252,52
		2980lm	60°	25	1005782	252,52
		3530lm	24°	19	1005786	252,52
	3000K	3490lm	36°	19	1005787	252,52
		3210lm	60°	25	1005788	252,52
		3800lm	24°	19	1005792	252,52
	4000K	3760lm	36°	19	1005793	252,52
		3460lm	60°	25	1005794	252,52





Wer ein Projekt mit SLV NUMINOS® Downlights oder Spots verwirklicht hat, kann sich beruhigt zurücklehnen. Denn durch die Qualität der verbauten LED-Module und Treiber sind Langlebigkeit und Lichtqualität garantiert. Wann starten Sie Ihr Projekt mit dem SLV NUMINOS® Leuchtensystem?

SYMBOLERKLÄRUNG



Dimmbar mit ...

- C = Phasenabschnittsdimmer
- Dali = Dali Bussystem

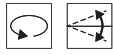

Dreh- und Schwenkbarkeit in Grad:

- Drehbereich
- Schwenkbereich



Der Halbstreuwinkel

beschreibt den Ausstrahlungswinkel in Grad. Je kleiner der Winkel desto stärker wird das Licht gebündelt.



Netzkabellänge in cm



Pendelkabellänge in cm



Leuchten mit eingebauten LEDs

Die Lichtquelle dieser Leuchte darf nur vom Hersteller oder einem von ihm beauftragten Servicetechniker ersetzt werden.



Der Lichtstromerhalt

Beschreibt um wie viel der Lichtstrom einer LED im angegebenen Zeitraum abnimmt.



UGR = Unified Glare Rating

Je niedriger der UGR-Wert, desto geringer die psychologische Blendung.



Farbtemperatur



Lumen



Steuerung



Schutzklassen

- Schutzklasse I / Schutzleiter
- Schutzklasse II / Schutz durch doppelte oder verstärkte Isolierung
- Schutzklasse III / Schutz durch Kleinspannung



Der **IK-Stoßfestigkeitsgrad** ist ein Maß für die Widerstandsfähigkeit von Gehäusen elektrischer Betriebsmittel gegen mechanische Beanspruchung, insbesondere Stoßbeanspruchung.



IP-Schutzart

Gibt die Eignung elektrischer Betriebsmittel für verschiedene Umgebungsbedingungen an.



Unabhängiger Konverter

(Betriebsgerät auch zur Verwendung außerhalb von Leuchten)



Kurzschlussfestes Sicherheitsbetriebsgerät



- Einsatz **ausschließlich** für Innenräume
- **Ungeeignet** für die Anwendung in Innenräumen



Kennzeichnet Produkte mit **eingebauten LEDs**



Kennzeichnet Leuchten aus einer **Leuchtenfamilie**



Ihren optionalen Treiber (On/Off, Phasendimmung, DALI) und passende Diffusoren können Sie über die **Farbkodierung** ganz einfach hinzufügen.

Bitte beachten Sie:

Ein großer Teil der in diesem Katalog vorgestellten Produkte ist durch Warenzeichen, Geschmacksmuster, Gebrauchsmuster oder Patente geschützt. Ein Verstoß gegen diese Schutzrechte oder eine Verwendung von Text- und Layoutgestaltung sowie urheberrechtlich geschützten Bildern ohne unsere Genehmigung wird gerichtlich verfolgt. Die in diesem Katalog enthaltenen Abbildungen und Angaben dienen nur der Veranschaulichung und sind unverbindlich in Farbe, Form, Ausführung und technischen Daten. Bei sämtlichen Produktbeschreibungen/-angaben bleiben Änderungen und Irrtümer daher vorbehalten.

Alle Produkte unseres Sortiments unterliegen einer strengen Qualitätssicherung und erfüllen die allgemein gültigen Normen. Dieser Katalog beinhaltet ein allgemeines Sortiment und ist nicht landesspezifisch ausgelegt. Etwaige Abweichungen von landesspezifischen Vorgaben sind vor der Bestellung zu klären. SLV haftet nicht für gegebenenfalls abweichende technische Normen. Alle Gewichts- und Längenangaben sind in kg bzw. in cm angegeben, sofern nicht anders bezeichnet. Technische Änderungen vorbehalten!

Die Präsentation unserer Leuchten mit realistischen und beispielhaften Anwendungsfotos wird ermöglicht durch das freundliche Entgegenkommen und die Zustimmung der Eigentümer oder Gestalter der jeweils vordergründig in den Bildern zu sehenden Umgebungen. All jenen, die durch ihr Einverständnis zur Entstehung und Verwendung unserer Fotos beigetragen haben, sei an dieser Stelle nochmals herzlich gedankt!

Unser gesamtes Sortiment finden Sie auf unserer Internetseite slv.com und im aktuellen Katalog BIG WHITE® 2022.



Herausgeber
SLV GmbH, Deutschland
Daimlerstraße 21-23
52531 Übach-Palenberg

Deutschland:
T +49 (0) 2451 4833 - 0
International:
T +49 (0) 2451 4833 - 355

slv.com

Copyright
© SLV GmbH, 2022

Bildnachweise
SLV GmbH
www.gettyimages.de

slv.com
