



Paulmann

IP44



Info

www.paulmann.com

Paulmann Licht GmbH
Quezinger Feld 2
31832 Springe
Germany

www.paulmann.com

Art.-Nr.: 501.37

PSRC 07/22



Li-MnO₂
1x CR2450

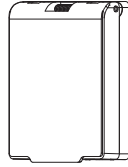

1x

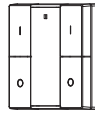

1x

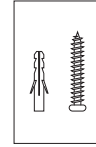

Incl.

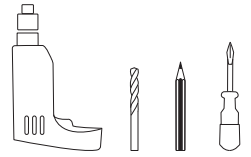

	Group A	a1	Click	On	Hold	Dimming +
		a0	Click	Off	Hold	Dimming -
	Group B	b1	Click	On	Hold	Dimming +
		b0	Click	Off	Hold	Dimming -
	Indicator	c		Blinking		Constant On

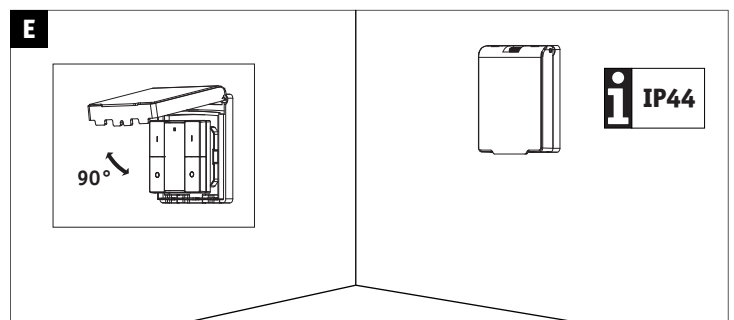
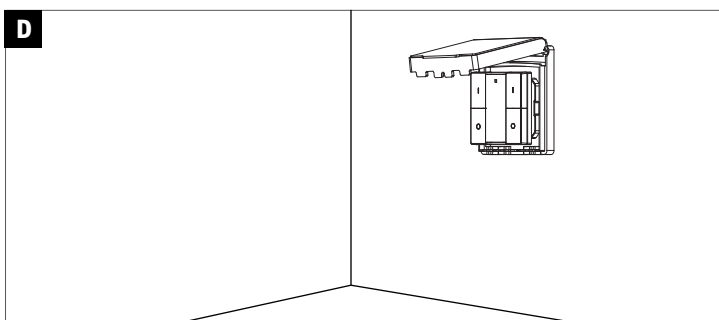
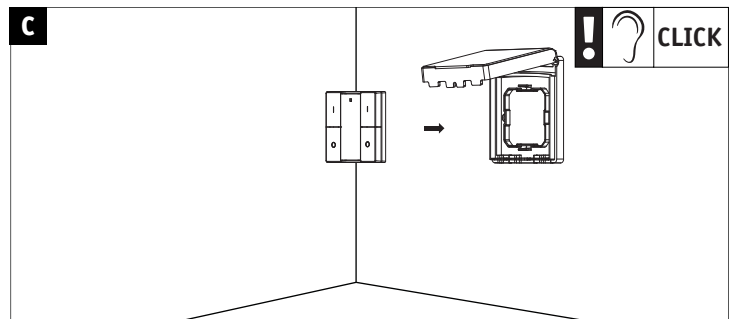
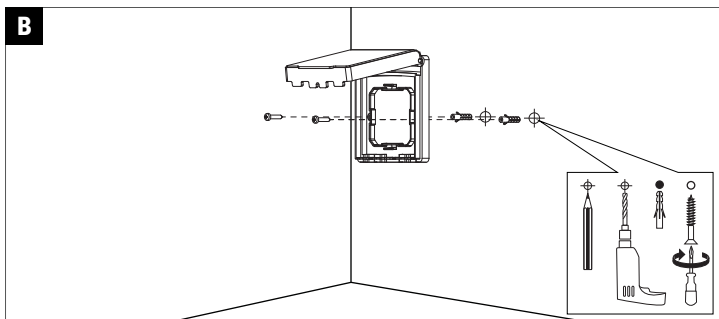
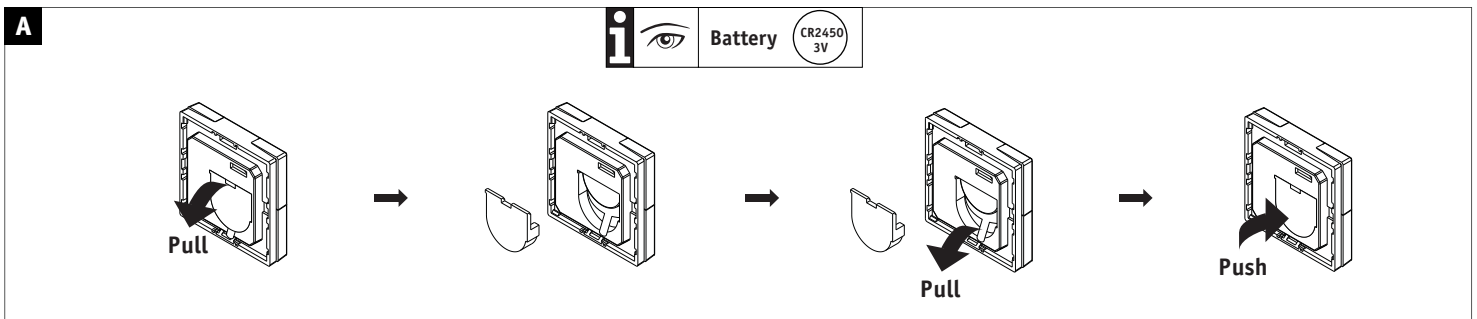

without Gateway

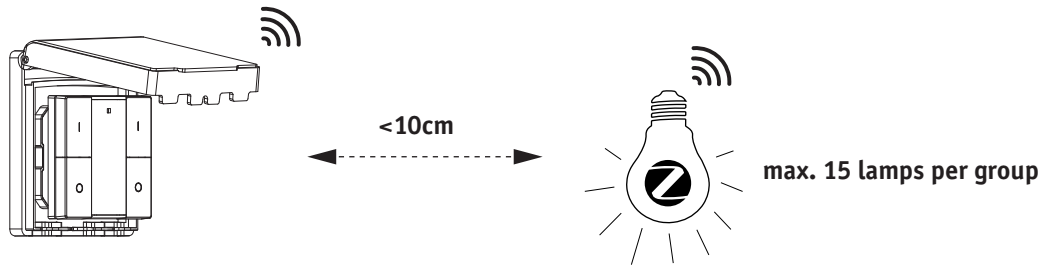

<p>Touchlink Connect</p>	<p>a1 Click Group A</p> <p>or</p> <p>b1 Click Group B</p>	<p><1 sec</p>	<p>a1 + b1 Hold</p>	<p><1 sec</p>	<p>a0 Click → 3 sec → 6x</p>
<p>Touchlink Remove</p>	<p>a1 Click Group A</p> <p>or</p> <p>b1 Click Group B</p>	<p><1 sec</p>	<p>a1 + b1 Hold</p>	<p><1 sec</p>	<p>a0 Click 2x <1 sec → 3 sec → 6x</p>

with Gateway

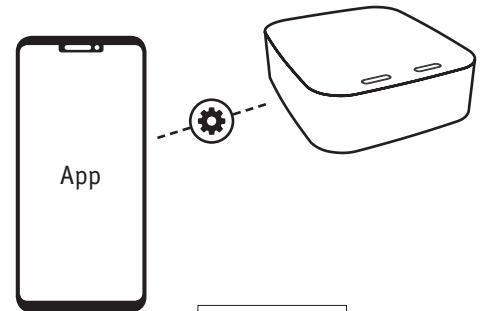
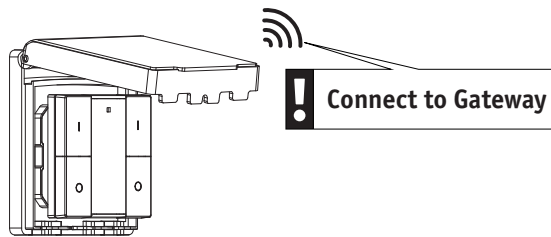

Learn more:
www.paulmann.com/zb

<p>Ready for Gateway</p>	<p>Factory Reset</p> <p>a0 + b0 Click 3x <2 sec → 20 sec</p>
---------------------------------	---

Factory Reset

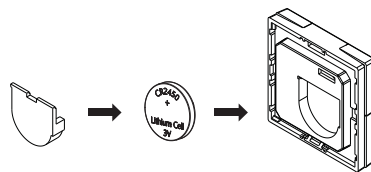
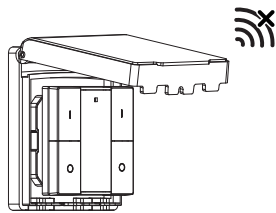

1x Li-MnO₂ Battery (3V 620mAh)

<p>Factory Reset</p>	<p>a0 + b0 Click 3x <2 sec → 3x</p>
-----------------------------	---

Zugelassen für den Betrieb in allen Ländern der EU / Approved for operating in all European countries
CE: Konform mit / in accordance with / conformance a 2014/53/EU <http://www.paulmann.com/ce>

2,4 GHz –
2,4835 GHz



Doesn't apply for the geographical area within a radius of 20km from the centre on "Ny Alesund"

Hiermit erklärt Paulmann Licht, dass der Funkanlagentyp [501.37] der Richtlinie 2014/53/EU entspricht.
Der vollständige Text der EU-Konformitätserklärung ist unter der folgenden Internetadresse verfügbar: www.paulmann.com/ce
Funk-Frequenz [2,4 GHz – 2,4835 GHz] Abgestrahlte Energie [10 mW]