



Paulmann

### Safety Instructions

1, 2, 3, 4, 5, 6, 8, 11, 12, 15, 16,  
19, 20, 21, 22, 24, 33, 34



Info

[www.paulmann.com](http://www.paulmann.com)

Paulmann Licht GmbH  
Quezinger Feld 2  
31832 Springe  
Germany

[www.paulmann.com](http://www.paulmann.com)

Art.-Nr.: 968.20

968.21

968.22

(+MA326) PSU 12/20

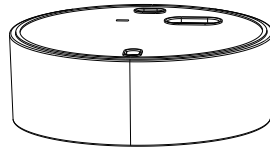

1x

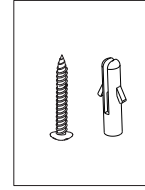

Incl.

A

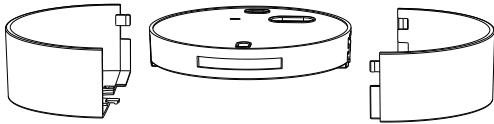
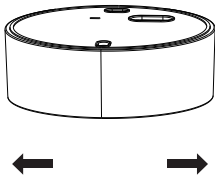

B

Nr. 4, 5, 7

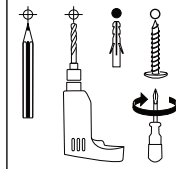
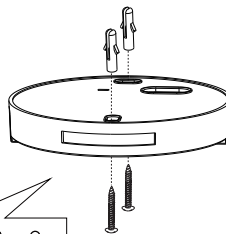

C

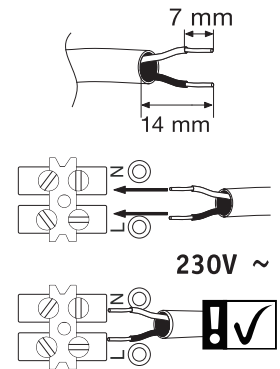

D

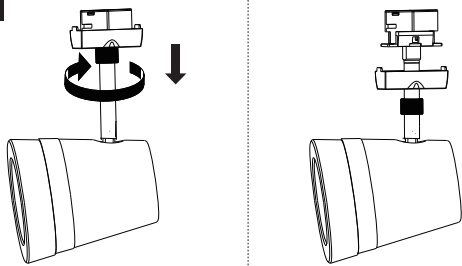

not incl.  
Spot Cone



Paulmann

Art.-Nr.: 976.13

953.62

969.25

E

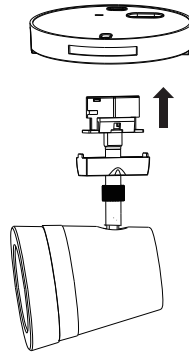

F

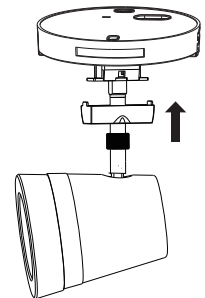

G

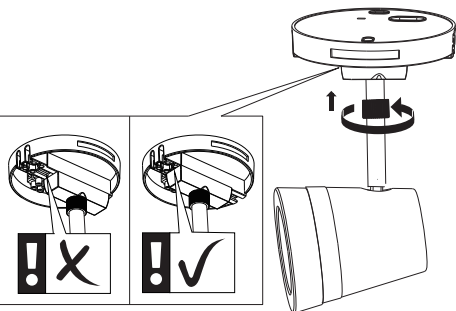

H

